

LOADING DOCK EQUIPMENT

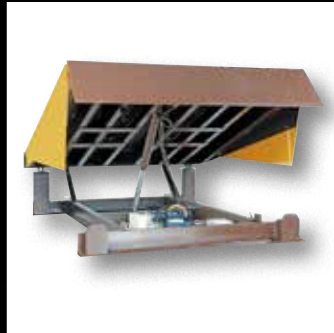

DOCK LEVELERS



DOCK SEAL & SHELTERS

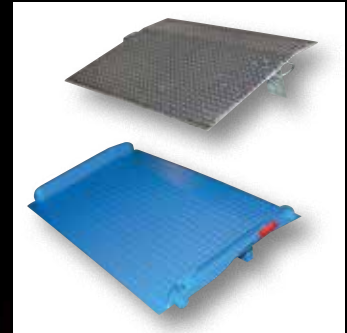

DOCKPLATES & DOCKBOARDS



WHEEL CHOCKS



TRAILER STABILIZING JACKS



DOCK BUMPERS

Truck Scissor Dock Lifts v	A2-A3
Dock Levelers v	A3-A5, A42
Dock Safety & Maintenance v	A6-A9
Dock Seals and Dock Shelters v	A10-A11 & A42
Vinyl Strip Doors v	A12
Dock Bug Doors & Chutes b	A13
Yard Ramps v	A14-A16
Dockplates and Dockboards v	A16-A20
Wheel Risers v	A21
Walk & Service Ramps v r	A22-A25
Hose & Cable Crossovers v i	A26-A28
Loading Lights r i	A29-A30
Cargo Bars & Strapping v i	A31-A32
Wheel Chocks & Accessories v i	A33-A36
Trailer Stabilizing Jacks v	A36-A37
Dock Bumpers i	A38-A40
Pallet Pullers i	A41
Pry Lever Bars v	A41



Shown with Optional Aluminum Bridge (one steel bridge standard)

Premium Truck Scissor Dock Lifts

Save time and reduce man-hours where there are no docks with a Truck Scissor Dock Lift. The pit or surface mount has an optional approach ramp. Engineered and designed for maximum safety and efficiency. The diamond plate deck is made of heavy gauge steel for years of use. Hydraulic cylinders feature emergency velocity fuse if line breaks. It comes complete with upper travel limit switch and overload relief valve. The push button control is on a 20 foot long coil cord. Pre-wired control box includes magnetic starter with overload relay. High visibility safety yellow removable handrails with fixed toe boards are standard. Includes beveled toe-guards and electric toe-guards around perimeter of platform. Standard external 6.5 HP 460V, 3-phase, 60 Hz motor can be located up to 8 feet away from lift (weighs 300 lb.)

460V 3-PHASE STD. OPTIONS ON PG. A3



Standard with Electric Toe-guards

OPTIONS

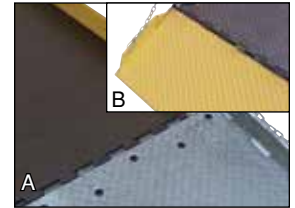

A) ALUMINUM BRIDGE • WL-SATB
B) STEEL BRIDGE • WL-SSTB



REMOVABLE HANDRAIL AND TOEBOARDS
model WL-RHT



STOP SIGNAL SIGN
model WL-SSS



COLD GALVANIZED COATING

MODEL NUMBER	PLATFORM (W x L)	LOWERED HEIGHT	RAISED HEIGHT	UNIFORM CAPACITY	OVERALL FRAME SIZE (W x L)	WEIGHT (POUND)
WL-100-5-48	48" x 96"	8"	68"	5,000 lb.	41" x 93"	3125
WL-100-5-68	72" x 96"	8"	68"	5,000 lb.	62" x 93"	3485
WL-100-5-78	84" x 96"	8"	68"	5,000 lb.	62" x 93"	3706
WL-100-5-88*	96" x 96"	8"	68"	5,000 lb.	86" x 93"	3957
WL-100-5-610	72" x 120"	8"	68"	5,000 lb.	62" x 118"	3828
WL-100-5-710	84" x 120"	8"	68"	5,000 lb.	62" x 118"	4032
WL-100-5-810*	96" x 120"	8"	68"	5,000 lb.	86" x 118"	4112
WL-100-6-68	72" x 96"	10"	70"	6,000 lb.	62" x 93"	3648
WL-100-6-78	84" x 96"	10"	70"	6,000 lb.	62" x 93"	3793
WL-100-6-88*	96" x 96"	10"	70"	6,000 lb.	86" x 93"	4172
WL-100-6-610	72" x 120"	10"	70"	6,000 lb.	62" x 118"	3944
WL-100-6-710	84" x 120"	10"	70"	6,000 lb.	62" x 118"	4043
WL-100-6-810*	96" x 120"	10"	70"	6,000 lb.	86" x 118"	4306
WL-100-8-68	72" x 96"	10"	70"	8,000 lb.	62" x 93"	4401
WL-100-8-78	84" x 96"	10"	70"	8,000 lb.	62" x 93"	4597
WL-100-8-88*	96" x 96"	10"	70"	8,000 lb.	86" x 93"	4703
WL-100-8-610	72" x 120"	10"	70"	8,000 lb.	62" x 118"	4812
WL-100-8-710	84" x 120"	10"	70"	8,000 lb.	62" x 118"	4918
WL-100-8-810*	96" x 120"	10"	70"	8,000 lb.	86" x 118"	5162
WL-100-10-68	72" x 96"	14"	72"	10,000 lb.	62" x 93"	5809
WL-100-10-78	84" x 96"	14"	72"	10,000 lb.	62" x 93"	5996
WL-100-10-88*	96" x 96"	14"	72"	10,000 lb.	86" x 93"	6182
WL-100-10-610	72" x 120"	14"	72"	10,000 lb.	62" x 118"	6042
WL-100-10-710	84" x 120"	14"	72"	10,000 lb.	62" x 118"	6229
WL-100-10-810*	96" x 120"	14"	72"	10,000 lb.	86" x 118"	6410
WL-100-10-612	72" x 144"	14"	72"	10,000 lb.	62" x 118"	6509
WL-100-10-712	84" x 144"	14"	72"	10,000 lb.	62" x 118"	6695
WL-100-10-812*	96" x 144"	14"	72"	10,000 lb.	86" x 118"	6881
WL-100-12-68	72" x 96"	14"	72"	12,000 lb.	62" x 93"	6392
WL-100-12-78	84" x 96"	14"	72"	12,000 lb.	62" x 93"	6578
WL-100-12-88*	96" x 96"	14"	72"	12,000 lb.	86" x 93"	6736
WL-100-12-610	72" x 120"	14"	72"	12,000 lb.	62" x 118"	6625
WL-100-12-710	84" x 120"	14"	72"	12,000 lb.	62" x 118"	6812
WL-100-12-810*	96" x 120"	14"	72"	12,000 lb.	86" x 118"	6998
WL-100-12-612	72" x 144"	14"	72"	12,000 lb.	62" x 118"	7103
WL-100-12-712	84" x 144"	14"	72"	12,000 lb.	62" x 118"	7230
WL-100-12-812*	96" x 144"	14"	72"	12,000 lb.	86" x 118"	7441

*Units 96" wide cannot ship LTL. These sizes will need to ship flat bed.

Premium Truck Scissor Dock Lift Options

SPLIT ALUMINUM TRUCK BRIDGE: Ideal for government applications. 72"W x 18"L. For 5 & 6K units. (110 lb. add'l bridge)

Replacement of standard steel bridge. **Model WL-SATB**
Additional split aluminum bridge. **Model WL-ADDSATB**

SPLIT STEEL BRIDGE: Split Steel Bridge that can be added to the opposite side of the Truck Scissor Dock Lift. 72" wide x 18" long. (180 lb. add'l bridge)
Model WL-SSTB

REMOVABLE HANDRAILS/TOEBOARDS: Used on a Truck Scissor Dock Lift that is mounted in a pit. This allows the platform to be flush with the floor for fork truck cross traffic. Please deduct 7½ (in.) from overall width for usable width. **Model WL-RHT**

ADDITIONAL HYDRAULIC LINE: Allows you to locate power unit further away from the lift. 8 foot of hose is standard.

Model WL-HH-(LENGTH) PER FOOT

APPROACH RAMP FOR 8" LOWERED HEIGHT: 60" wide x 65" long. 7° ramp angle. 397 lb. **Model WL-AR8**

APPROACH RAMP FOR 10" LOWERED HEIGHT: 60" wide x 82" long. 7° ramp angle. 517 lb. **Model WL-AR10**

APPROACH RAMP FOR 14" LOWERED HEIGHT: 60" wide x 116" long. 7° ramp angle. 788 lb. **Model WL-AR14**

****APPROACH RAMPS MUST BE ANCHORED TO THE FLOOR****

Premium Truck Scissor Dock Lift Options

WARNING BEEPER: Sounds during the lifting and lowering operations. 80 decibels. **Model WL-WBO**

WARNING STROBE LIGHT: Light flashes during the lifting and lowering operations. **Model WL-WLO**

WARNING BEEPER & STROBE: Sounds and flashes during the lifting and lowering operations on a Truck Scissor Dock Lift. 80 decibels. **Model WL-WB**

50,000 lb. ROLLOVER CAPACITY (25,000 lb. per axle): Adds additional structural channel supports for the deck. Increases lowered height 2". **Model WL-50** (adds 400 lb. to 6 x 8 units)

MOBILE WHEEL KIT: Kit may be used on the 5,000 and 6,000 lb. capacity units only. System includes casters and handle. (400 lb.) **Model WL-WK**

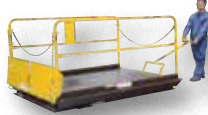

SPECIAL RESERVOIR MOUNTING: Available in a wall mount or a handrail mount (non-removable). **Model WL-RMB**



AUTOMATIC WHEEL CHOCKS: Block the dock end of ramp to avoid roll off as the unit lifts. This system requires a special pit mount. **Model WL-AWC**

STOP SIGNAL SIGN: Optional Stop Sign Signal that raises up to let the driver know when to stop for safe loading/unloading. This is only available on surface mount units with fixed toe boards. **Model WL-SSS** (reduces usable width by 3")

KEY SWITCH LOCKOUT: Avoids unauthorized use of the lift. This option will lock out the controls at the power unit. **Model WL-KL**

TWO SPEED PUMP: Increase lifting speed by 55% when lift is unloaded. Ideal for unloading applications. **Model WL-TSP**

VOLTAGE CHANGE: Change the power from standard 460V 3 phase to 208/230V 3 phase. **Model VCC-208/230-3**

3 HP SINGLE PHASE ELECTRIC MOTOR: Replace standard three phase power unit with 208/230V, 1 phase, 60Hz power unit (approx.: 1½ gallons per minute pump speed). **Model WL-3HP**

7-1/2 HP POWER UNIT: Power unit is wired for three phase 208-230/460V 60Hz, unit will pump approximately 6 gallons per minute. **Model WL-7HP**

10 HP POWER UNIT: Power unit is wired for three phase 208-230/460V 60Hz, unit will pump approx. 8 gallons/min. **Model WL-10HP**

SAFETY ACCORDION SKIRT: Keep people and debris from getting under the lift.

COLD GALVANIZED LIQUID COATING: For application usage visit www.zrcworldwide.com **Model SPO-WL-LS-ZRC**

STEEL-IT™ COATING: Visit www.steel-it.com for application usage. **Model SPO-WL-LS-SSC**

IMMERSION OIL HEATER: For cold weather applications with a built in metal reservoir & thermostat for automatic heat control. 208-230V single or three (3) phase power, 250 watts. This option can only be used in steel tanks. **Model IOH-230V**

Use with 460V 3 phase power unit, 500 watts. **Model IOH-460V**

APPROACH PLATE: 48" wide treadplate. **Model WL-AR8-48**

Truck Actuated Dock Levelers

- 55,000 psi high strength checker plate deck
- 12" long lip (extends 6½" into truck)
- Toeguards on each side
- Service range of 12" above through 8" below dock
- (2) Molded Bumpers; 5"W x 16"H x 6"D
- Lift By-Pass for Safety

This is a fully automatic loading ramp where there is no dock attendant needed. It consists of a lift by-pass for safety and toe guards on each side. As the truck backs against the twin actuating arms (bumpers) it pushes the carriage back. As the carriage goes back the deck goes up. When the carriage bumpers contact the dock, the deck floats down to rest on the trailer. When the truck pulls out, the deck returns to level supported position automatically.



RECESSED DOCK LEVELER series RU



DOCK LEVELER WITH LEGS FOR FRONT OF DOCK PLACEMENT series PU

MODEL NUMBER	DESCRIPTION	UNIFORM CAPACITY	WEIGHT (POUND)
RU-600-SCB	6'W x 6'L Recessed Unit, Standard 28" Deep Pit	20,000 lb.	2036
RU-800-SCB	6'W x 8'L Recessed Unit	20,000 lb.	2399
RU-800-SCB-F	6'W x 8'6"L Recessed Unit	20,000 lb.	2475
RU-1000-SCB	6'W x 10'L Recessed Unit	20,000 lb.	2702
SU-600-SCB	6'W x 6'L Recessed Unit with Legs, Full 48" Deep Pit	20,000 lb.	2127
SU-800-SCB	6'W x 8'L Recessed Unit with Legs	20,000 lb.	2490
SU-800-SCB-F	6'W x 8'6"L Recessed Unit with Legs	20,000 lb.	2566
SU-1000-SCB	6'W x 10'L Recessed Unit with Legs	20,000 lb.	2793
PU-600-SCB	6'W x 6'L (Dock Leveler Unit with Legs for in Front of Dock Placement)	20,000 lb.	2372
PU-800-SCB	6'W x 8'L (Dock Leveler Unit with Legs for in Front of Dock Placement)	20,000 lb.	2802
PU-1000-SCB	6'W x 10'L (Dock Leveler Unit with Legs for in Front of Dock Placement) (SPECIFY DOCK HEIGHT WHEN ORDERING)	20,000 lb.	3172

TRUCK ACTUATED DOCK LEVELER OPTIONS

MODEL NUMBER	DESCRIPTION	WEIGHT (POUND)
WS-DV	DUAL VINYL WEATHER STRIPPING (FACTORY INSTALLED)	--
CAS-RU-600	CURB ANGLE SET FOR SERIES RU-600 DOCK LEVELER	154
CAS-RU-800	CURB ANGLE SET FOR SERIES RU-800 DOCK LEVELER	174
CAS-RU-800-F	CURB ANGLE SET FOR SERIES RU-800-F DOCK LEVELER	179
CAS-RU-1000	CURB ANGLE SET FOR SERIES RU-1000 DOCK LEVELER	193
TA-30K/6	30,000 POUND CAPACITY FOR 6 FOOT LENGTH	--
TA-30K/8	30,000 POUND CAPACITY FOR 8 FOOT LENGTH	--
TA-30K/10	30,000 POUND CAPACITY FOR 10 FOOT LENGTH	--
FI	FOAM INSULATION	6
TL	NOTCH FOR TRAILER LOCK	--
SPO	SHALLOW PIT OPTION (minimum depth 24")	--
SPO-RU	SHALLOW PIT OPTION FOR SERIES "RU"	--
BE	BUMPER EXTENSION FOR LOW DOCKS	--

CAPACITIES TO 100,000 POUNDS AVAILABLE - CONTACT FACTORY



HEAVY-DUTY SPRINGS HELP LIFT THE DECK WHEN A TRUCK COMES INTO CONTACT WITH THE DOCKLEVELER

DOCK LEVELER SURVEY SHEET CAN BE FOUND ON PAGE A42



RATCHET CONTROL AND ACTUATION SPRINGS



EASY OPERATION

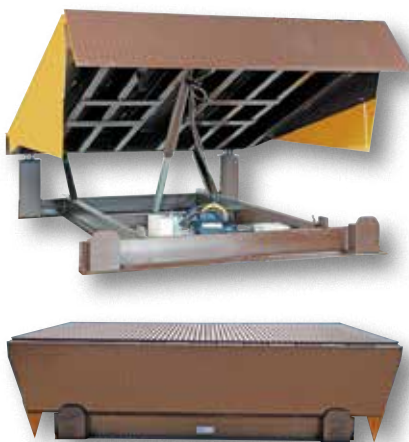

CONTROL BOX

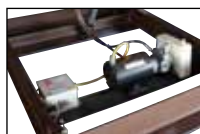

STATE-OF-THE-ART HYDRAULIC DESIGN



DOCK LEVELER SURVEY SHEET CAN BE FOUND ON PAGE A42

Mechanical Dock Levelers

The Mechanical Dock Leveler is constructed of heavy duty diamond plate deck (55,000 PSI) steel for long term support of the steel channel understructure. The dock leveler allows for easy truck loading and unloading. The leveler is engineered and designed for minimum maintenance and features a smooth pull chain operation. Lip is 16" long. Service range 12" above and below dock. Includes two (2) 1014-4.5 laminated bumpers. Other capacities available, contact factory.

MODEL NUMBER	OVERALL SIZE WITH LIP	OPERATION	UNIFORM CAPACITY	WEIGHT (POUND)
RR-65-20	6'W x 5'4"L	Pull Chain	20,000 lb.	1570
RR-66-20	6'W x 6'4"L	Pull Chain	20,000 lb.	1766
RR-68-20	6'W x 8'4"L	Pull Chain	20,000 lb.	2144
RR-610-20	6'W x 10'4"L	Pull Chain	20,000 lb.	2517
RR-75-20	7'W x 5'4"L	Pull Chain	20,000 lb.	1766
RR-76-20	7'W x 6'4"L	Pull Chain	20,000 lb.	1970
RR-78-20	7'W x 8'4"L	Pull Chain	20,000 lb.	2382
RR-710-20	7'W x 10'4"L	Pull Chain	20,000 lb.	2808

CONTACT FACTORY FOR CUSTOM-BUILT APPLICATIONS

Electric Hydraulic Dock Levelers **460V 3-PHASE STD, OPTIONS ON PG. C2**

The Electric Hydraulic Dock Leveler is ideal for high usage dock areas. The hydraulic design consists of a simple push of the button operation. The operator pushes and holds the "raise" button which activates the hydraulic pump and raises the deck. When the deck reaches the raised position the lip automatically extends. The operator releases the "raise" button and the deck descends to rest on the trailer. The control box includes a red emergency stop button standard. When the truck pulls away, the deck descends to full down position, trips the limit switch, and returns automatically to the level cross traffic position. Includes telescopic steel toe guards on both sides, flush with platform edge, service range of +/- 12", and two (2) 1014-4.5 laminated bumpers. Uniform capacities available up to 80,000 pounds, contact factory.

MODEL NUMBER	OVERALL SIZE WITH LIP	OPERATION	UNIFORM CAPACITY	WEIGHT (POUND)
EH-65-20	6'W x 5'4"L	ELECTRIC HYDRAULIC	20,000 lb.	1346
EH-66-20	6'W x 6'4"L	ELECTRIC HYDRAULIC	20,000 lb.	1599
EH-68-20	6'W x 8'4"L	ELECTRIC HYDRAULIC	20,000 lb.	1890
EH-610-20	6'W x 10'4"L	ELECTRIC HYDRAULIC	20,000 lb.	2310
EH-75-20	7'W x 5'4"L	ELECTRIC HYDRAULIC	20,000 lb.	1501
EH-76-20	7'W x 6'4"L	ELECTRIC HYDRAULIC	20,000 lb.	2000
EH-78-20	7'W x 8'4"L	ELECTRIC HYDRAULIC	20,000 lb.	2300
EH-710-20	7'W x 10'4"L	ELECTRIC HYDRAULIC	20,000 lb.	2940

CONTACT FACTORY FOR CUSTOM-BUILT APPLICATIONS

MECHANICAL & ELECTRIC HYDRAULIC DOCK LEVELER OPTIONS

MODEL NUMBER	DESCRIPTION	WEIGHT (POUND)
WS-DV	DUAL VINYL WEATHER STRIPPING PRE-INSTALLED	--
ES	EMERGENCY STOP (RR-SERIES ONLY)	54
SPO	SHALLOW PIT OPTION (1 1/2" MINIMUM DEPTH)	--
FI	UNDER-DECK FOAM INSULATION	6
18"LIP/6	18" LONG LIP FOR 6' WIDE DOCK LEVELER	31
18"LIP/7	18" LONG LIP FOR 7' WIDE DOCK LEVELER	36
FOD/6'	LEG OPTION FOR IN FRONT OF DOCK PLACEMENT (6' LENGTH)	240
FOD/8'	LEG OPTION FOR IN FRONT OF DOCK PLACEMENT (8' LENGTH)	240
FOD/10'	LEG OPTION FOR IN FRONT OF DOCK PLACEMENT (10' LENGTH)	240
CAS-65	CURB ANGLE SET FOR 6' x 5' DOCK LEVELER	149
CAS-66	CURB ANGLE SET FOR 6' x 6' DOCK LEVELER	159
CAS-68	CURB ANGLE SET FOR 6' x 8' DOCK LEVELER	178
CAS-610	CURB ANGLE SET FOR 6' x 10' DOCK LEVELER	198
CAS-75	CURB ANGLE SET FOR 7' x 5' DOCK LEVELER	161
CAS-76	CURB ANGLE SET FOR 7' x 6' DOCK LEVELER	171
CAS-78	CURB ANGLE SET FOR 7' x 8' DOCK LEVELER	190
CAS-710	CURB ANGLE SET FOR 7' x 10' DOCK LEVELER	210
SS/65	STEEL SHELL FOR 6' x 5' POUR IN PLACE INSTALLATION	218
SS/66	STEEL SHELL FOR 6' x 6' POUR IN PLACE INSTALLATION	285
SS/68	STEEL SHELL FOR 6' x 8' POUR IN PLACE INSTALLATION	290
SS/610	STEEL SHELL FOR 6' x 10' POUR IN PLACE INSTALLATION	298
SS/75	STEEL SHELL FOR 7' x 5' POUR IN PLACE INSTALLATION	238
SS/76	STEEL SHELL FOR 7' x 6' POUR IN PLACE INSTALLATION	252
SS/78	STEEL SHELL FOR 7' x 8' POUR IN PLACE INSTALLATION	264
SS/710	STEEL SHELL FOR 7' x 10' POUR IN PLACE INSTALLATION	277
EH-TL*	ELECTRIC INTERLOCK (EH DOCK LEVELER & TRAILER RESTRAINT)	-

*TRAILER RESTRAINT SOLD SEPARATELY

20" LIP RECOMMENDED FOR REFRIGERATED TRUCKS, CONSULT FACTORY FOR PRICING

Edge-O-Dock Levelers

The Edge-O-Dock Leveler permanently attaches to face of dock. It is recommended for docks to be at least forty-eight (48) inches high. When the trailer departs, the lip drops automatically behind the face of the bumpers. Concrete recess is not required. It comes complete with (2) two 2" x 8" x 18" bumpers and installation instructions. Standard ramping is twenty-seven (27) inches, with a thirty-six (36) inch long ramping length available for smaller grade. A steel dock edge, or approach ramp is required for proper installation.

The **Mechanical Edge-O-Dock** is operated by placing the actuation handle into the pocket of the inner lip and pulling down toward the floor. The operator then pushes the handle forward until the lip rests on the truck bed. As the trailer departs, the lip retracts behind the bumper face automatically.

The **Hydraulic Hand Pump** system is used to lift the leveler and extend the lip. The operator rotates the relief valve allowing the deck to descend down and rest upon the trailer. Unit comes complete with hand pump, wall-mount brackets, cylinder, 15 feet of hydraulic line and oil. Truck must pull out for leveler to return to stored position.

The **Electric Hydraulic Edge-O-Dock** is the easiest to operate. After the truck is backed against the dock, push and hold the control button. The leveler raises and the lip will extend. 115V, 1 phase power standard. Unit comes complete with motor, pump, control box, cylinder, lines, and oil. Truck must pull out for leveler to return to stored position.



MECHANICAL • series FM



HYDRAULIC HAND PUMP series PP

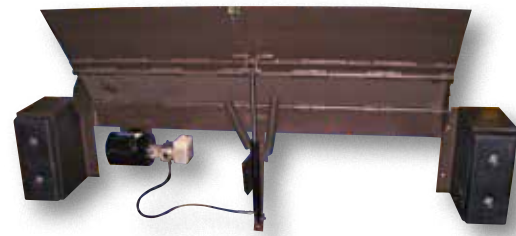

ELECTRIC HYDRAULIC • series PE

MODEL NUMBER	OPERATION	**USABLE WIDTH	UNIFORM CAPACITY	WEIGHT (POUND)
FM-0648	MECHANICAL	48"	6,000 lb.	406
FM-2066	MECHANICAL	66"	20,000 lb.	484
FM-2072	MECHANICAL	72"	20,000 lb.	510
FM-2078	MECHANICAL	78"	20,000 lb.	536
FM-2566	MECHANICAL	66"	25,000 lb.	514
FM-2572	MECHANICAL	72"	25,000 lb.	544
FM-3066	MECHANICAL	66"	30,000 lb.	632
FM-3072	MECHANICAL	72"	30,000 lb.	672
PP-1572-36*	HAND PUMP	72"	15,000 lb.	661
PP-2066	HAND PUMP	66"	20,000 lb.	505
PP-2072	HAND PUMP	72"	20,000 lb.	531
PP-2566	HAND PUMP	66"	25,000 lb.	538
PP-2572	HAND PUMP	72"	25,000 lb.	567
PP-2572-36*	HAND PUMP	72"	25,000 lb.	705
PP-3066	HAND PUMP	66"	30,000 lb.	655
PP-3072	HAND PUMP	72"	30,000 lb.	695
PE-1572-36*	ELECTRIC	72"	15,000 lb.	648
PE-2066	ELECTRIC	66"	20,000 lb.	492
PE-2072	ELECTRIC	72"	20,000 lb.	518
PE-2566	ELECTRIC	66"	25,000 lb.	525
PE-2572	ELECTRIC	72"	25,000 lb.	554
PE-2572-36*	ELECTRIC	72"	25,000 lb.	692
PE-3066	ELECTRIC	66"	30,000 lb.	642
PE-3072	ELECTRIC	72"	30,000 lb.	682

*DENOTES 36" RAMPING LENGTH FOR SMALLER GRADE

**OVERALL WIDTH IS USABLE WIDTH PLUS 27"

OPTIONAL STEEL FACE FOR BUMPER, model EOD-SF

115V 1-PHASE STD, OPTIONS ON PG. C2

EDGE-O-DOCKLEVELER OPTIONS		
MODEL NUMBER	DESCRIPTION	WEIGHT (POUND)
FM-HOOK	PULLING HOOK FOR MECHANICAL UNIT (OLD STYLE)	3
FM-BAR	ACTUATION HANDLE FOR MECHANICAL UNIT (NEW STYLE)	8
BB	STEEL BUMPER BOX	75
RB	RUBBER BUMPER (REPLACEMENT), 18"W x 8"H x 2"P	16
FM-FM	FM-SERIES (HOOK STYLE) TO FM-SERIES (HANDLE STYLE) CONVERSION KIT	12
FM-PP	FM-SERIES TO PP-SERIES CONVERSION KIT	53
FM-PE	FM-SERIES TO PE-SERIES CONVERSION KIT	89
PP-PE	PP-SERIES TO PE-SERIES CONVERSION KIT	56
CE	CURB EDGE - 6" CHANNEL x 96" LONG	90
CED	CANTED EDGE	--
RAMP-2	APPROACH RAMP 96"W x 12"L x 2"H	120
RAMP-4	APPROACH RAMP 96"W x 24"L x 4"H	215
AP	APPROACH PLATE 1/4" THICK x 12"L x 96"W	132
AP-BE	APPROACH PLATE 1/4" THICK x 12"L x 96"W WITH BEVELED EDGE	130



CONTROL BOX



Trailer Lock Systems 115V 1-PHASE STD, OPTIONS ON PG. C2

The Trailer Lock System is designed for installation directly in front of the loading dock. The electric hydraulic system captures the ICC bar on the back of semi-trailers. To ensure maximum safety the unit comes standard with an accumulator that allows the lock to follow the trailer up and down as it is loaded/unloaded. A beeper and flashing light warns the operator if the lock does not engage the trailer properly. A visual indication of the restraint's status is shown at all times by the traffic light outside and the control panel inside. It comes standard with light package, control panel, and three (3) large visual signs. Draw pull shear strength is 22,500 pounds per foot.

MODEL NUMBER	DESCRIPTION	WEIGHT (POUND)
TL-100-F	Electric Hydraulic, Aluminum Light Pkg. 115V, 1 PH	470
TL-100-F-S	Electric Hydraulic, Polypropylene Light Pkg. 115V, 1 PH	518
TL-100-F-S-LED	Electric Hydraulic, Polypropylene LED Light Pkg. 115V, 1 PH	518
TL-200-HP-F	Hand Pump Hydraulic, Aluminum Light Package	405
TL-200-HP-F-S	Hand Pump Hydraulic, Polypropylene Light Package	495

model TL-100-F
w/Aluminum Light Pkg.

Dock Traffic Systems

Our Dock Traffic Systems feature flashing red and green lights. Prevent accidents and injuries by providing clear communication between dock personnel and truck drivers. Built-in eyebrow type sun visors increase light visibility.

Deluxe, model DTS-10, consists of one (1) yellow aluminum traffic light with both a green and red lens (for outside), and an illuminated push-button control (for inside). Light measures 14"W x 21¾"H and features an 8" hood over each lens (recommended for west and south exposure). 60 Watt. 115V AC. Four (4) procedure signs are included. Features incandescent lights.

Economy, model DTS-5, comes with two (2) yellow polypropylene traffic lights, 6½"W x 11½"H, each having a green and a red lens. The light containing a toggle switch is placed inside the dock area for the dock attendant, and the other is placed outside for the truck driver. Four (4) signs are included. LED model never needs bulb replacements.



ALUMINUM DTS-10 POLYPROPYLENE DTS-5 LED LIGHTS DTS-5-LED

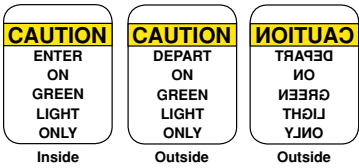

48 Hours to Ship

MODEL NUMBER	DESCRIPTION	POWER	WEIGHT (POUND)
DTS-10	Aluminum Housing, Incandescent Lights	115V, 1 Phase	30
DTS-5	Polypropylene Housing, Incandescent Lights	115V, 1 Phase	9
DTS-5-LED	Polypropylene Housing, LED Lights	115V, 1 Phase	8
DTS-5-LED-12DC	Polypropylene Housing, LED Lights	12V DC	8
DTS-5-LED-24DC	Polypropylene Housing, LED Lights	24V DC	8
DTS-5-LED-220V	Polypropylene Housing LED Lights	220V, 1 Phase	8

Weather Stripping (for pit mounted dock levelers)

The dock leveler Weather Stripping keeps out pests and rodents and maintains the proper working environment. The kit includes: (2) pre-cut side strips, (1) pre-cut foam insulator for the rear of the pit, and installation hardware.

The Dual Vinyl has a white dual-seal that attaches to the side of dock levelers with self-tapping sheet metal screws. The replacement vinyl slides into extruded channel that is attached with self-tapping screws. The easy install Brushes bolt on to the aluminum extrusion sides of the lever then simply slide brushes into aluminum extrusion channel.



DUAL VINYL series WS-DV



48 Hours to Ship



BRUSH series WS-RB

DUAL VINYL	MODEL NUMBER	LENGTH (PIT / STRIP)
	WS-5-DV	50" / 41"
	WS-6-DV	62" / 53"
	WS-8-DV	85" / 77"
	WS-10-DV	110" / 101"

REPLACEMENT VINYL	MODEL NUMBER	LENGTH (PIT / STRIP)
	WS-5-RV	50" / 42"
	WS-6-RV	62" / 54"
	WS-8-RV	85" / 78"
	WS-10-RV	110" / 102"

1" REPLACEMENT BRUSH	MODEL NUMBER	LENGTH (PIT / STRIP)
	WS-5-RB-1	50" / 42"
	WS-6-RB-1	62" / 54"
	WS-8-RB-1	85" / 78"
	WS-10-RB-1	110" / 102"

1-1/2" REPLACEMENT BRUSH	MODEL NUMBER	LENGTH (PIT / STRIP)
	WS-5-RB-1.5	50" / 42"
	WS-6-RB-1.5	62" / 54"
	WS-8-RB-1.5	85" / 78"
	WS-10-RB-1.5	110" / 102"

Dock Leveler Insulation Blanket

The Dock Leveler Insulation Blanket helps improve heating efficiency while using less energy. Prevents cold air from entering your warehouse from cracks that surround the dock door and leveler. The blanket includes aluminum extrusion, anchors, and hangers that fit most standard doors. The hangers allow for a secure raised blanket position. The blanket will pay for itself many times over by controlling heat loss.



MODEL NUMBER	OVERALL SIZE (W x L)	DESCRIPTION	WEIGHT (POUND)
DIB-96	90" x 96"	INSULATION BLANKET	17

Dock Barricades - Designed to Prevent Loading Dock "Run Off's" 115V 1-PHASE STANDARD

The Dock Barricade represents the next generation of innovative loading dock safety systems. The electric/hydraulic power unit provides quick and effortless operation. It can stop a four thousand (4,000) pound loaded truck at four (4) miles per hour. It is electronically operated and consists of an electrical bumper-style safety stop circuit to sense obstructions when lowering. Installation is simple, anchor the unit to the floor, mount the control on the wall and plug in. Mechanical unit, model DJG-100MW, features a manual hand crank winch to raise/lower barricade arm. All units include a lock bar on the arm post to restrict rotation of the barricade arm, padlock is NOT included.



MECHANICAL • DJG-100MW

MODEL NUMBER	DOOR SIZE (W x H)	ARM HEIGHT RAISED	ARM HEIGHT LOWERED	OVERALL (W x L)	WEIGHT (POUND)
DJG-100*	8' x 8'	148 ⁵ / ₈ "	28 ¹ / ₂ "	24" x 130 ³ / ₄ "	780
DJG-100-10*	10' x 10'	172 ⁵ / ₈ "	28 ¹ / ₂ "	24" x 154 ³ / ₄ "	800
DJG-100MW	8' x 8'	149"	32"	24" x 133 ¹ / ₄ "	408

*ELECTRIC HYDRAULIC POWERED UNITS

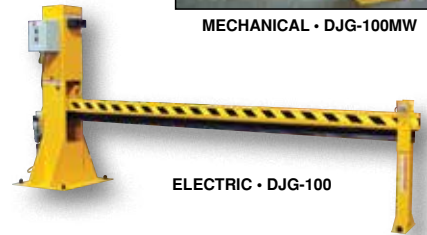

ELECTRIC • DJG-100

Safety Lift Gates

Simply lift and the self folding action folds the gate in a vertical position. With the assistance of the air assist cylinder the gate can be lifted with the slightest effort. The Lift Gate is manufactured of steel tubing with a yellow baked-in powder-coated toughness. Unit can be either wall or floor mounted. Ideal on loading dock doors to help reduce the possibility of people falling.

MODEL NUMBER	LENGTH	BASE PLATE (W x L)	HORIZONTAL UPPER BAR HEIGHT	OVERALL HEIGHT RAISED	WEIGHT (POUND)
SLG-6	6'	4" x 4"	42 ⁵ / ₈ "	111"	23
SLG-8	8'	4" x 4"	42 ⁵ / ₈ "	135"	28
SLG-10	10'	4" x 4"	42 ⁵ / ₈ "	159"	33

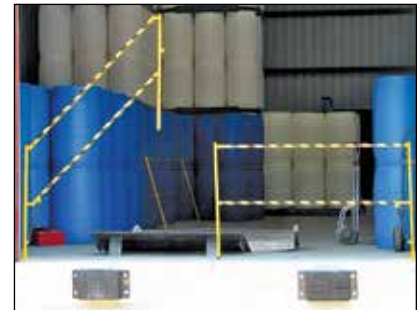

TWO SIX FOOT SECTIONS SHOWN

Economical Safety Swing Gate

An economical way to protect people from dock falls. Durable railings are constructed from schedule 10 pipe (1⁵/₈" O.D.). Units have a top rail height of 46¹/₄" and a 25" mid-rail. 4" poly-on-poly wheel allows units to be swung out of the way. Foot release lock keeps the railing from being moved when in use. Cast single socket is included. Yellow baked-in powder-coated toughness.



MODEL NUMBER	MATERIAL	OPENING WIDTH	HEIGHT	WEIGHT (POUND)
SSG-9	STEEL	108"	46 ¹ / ₄ "	105
SSG-11	STEEL	132"	46 ¹ / ₄ "	138





POWDER COATED TOUGH



Dock Chain Bollard Barrier System

The Dock Chain Bollard Barrier creates a safe environment for both personnel and products. The steel constructed double chain design adds extra security for doors up to 10'. Unit is designed with a safety yellow baked-in powder-coated toughness for clear visibility, and a bolt on chain hook-up enabling a quick installation or removal. Chains are mounted at 21" and 42" high on the bollard and the chain can be cut to size upon request. Series DCBB-42 include two (2) bollards, two (2) 127" long chains and one (1) DCBB-B-KIT. Concrete anchor hardware available separately.

Model DCBB-B-KIT is for use with existing bollards. Kit includes four (4) mounting brackets, four (4) quick links for chain, one (1) chain post handle and hardware.

MODEL NUMBER	OVERALL HEIGHT	BOLLARD DIAMETER	ACCOMMODATES DOOR SIZE	WEIGHT (POUND)
DCBB-42-4.5	42"	4.5"	10 FOOT	80
DCBB-42-5.5	42"	5.5"	10 FOOT	84
DCBB-B-KIT	BOLLARD CONVERSION KIT			2
BOL-CHAIN	3/16" STEEL POWDER COAT CHAIN (PER FOOT)			30
AS-344-4PK [Ⓞ] ✓	ANCHOR BOLTS FOR CONCRETE (4) 3/4" x 4 1/4"			4

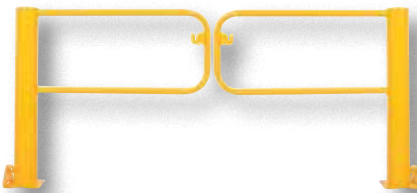

New

SECURE GATE IN OPEN OR CLOSED POSITION WITH PADLOCK (NOT INCLUDED).

Swivel Dock Gate

The Swivel Dock Gate is ideal for securing loading docks, parking lots or pathways. The gate features a steel construction for durability and a yellow powder coat finish for clear visibility. An attachable swing stop is added to the base of each bollard to reduce the wing length of gate arms, and to change the direction of gate swing. A chain slot is also attached to the end of each gate arm for the option of added security. All models come in pairs. Units have pre-drilled mounting holes for easy installation.

MODEL NUMBER	ACCOMMODATES DOOR SIZE	OVERALL HEIGHT	BOLLARD DIAMETER	WEIGHT (POUND)
SDG-8	8 foot	42 1/16"	5 1/2"	150
SDG-9	9 foot	42 1/16"	5 1/2"	170
SDG-10	10 foot	42 1/16"	5 1/2"	190
AS-344-4PK [Ⓞ] ✓	ANCHOR BOLTS FOR CONCRETE (4) 3/4" x 4 1/4"			4



model CLB-5-78L

Clearance Bars

Clearance Bars are low maintenance, highly visible, and simple to read. These easy to install clearance bars are made of 1/4" nominal wall lo-density polyethylene. Comes with eye hooks attached, chain not included. Standard lettering is "CLEARANCE" and specified height. Other colors and specified lettering available, contact factory.

MODEL NUMBER	OUTSIDE DIAMETER	LENGTH	LETTERING	COLOR	WEIGHT (POUND)
CLB-5-78P	5 1/4"	78"	NO	YELLOW	15
CLB-5-78L	5 1/4"	78"	YES	YELLOW	15
CLB-7-110P	7 1/2"	110"	NO	YELLOW	20
CLB-7-110L	7 1/2"	110"	YES	YELLOW	20



ECONOMY WARNING BARRIER • model ODG-121-F



DELUXE WARNING BARRIER • model ODG-133-BL

Overhead Door Warning Barriers

48 Hours to Ship

Protect overhead doors from fork truck damage. Heavy-duty PVC construction is light-weight and will not rust. Highly visible black and yellow safety tape and two American flags serve as a visual warning. Includes two 15' long chains with quick connects to hang barrier from ceiling or existing overhead door track.

Model ODG-133-BL features built-in warning sirens and flashing lights that activate when the barrier is bumped or contacted. Provides an audible and visual warning before damage to overhead door is caused. 76 DB at 9 feet. Requires (4) 9V lithium batteries, not included.

MODEL NUMBER	DESCRIPTION	OVERALL LENGTH	WEIGHT (POUND)
ODG-121-F [Ⓞ]	ECONOMY WARNING BARRIER	120"	63
ODG-133-BL [Ⓞ]	DELUXE WARNING BARRIER	120"	66

Light Duty Swinging Traffic Doors

These Light Duty Traffic Doors are constructed with rotationally molded cross-linked polyethylene, making them extremely durable and capable of withstanding the wear and tear associated with sales-to-back room and walk-in cooler openings in high volume retail establishments. Known for their long-term value, they are ideal for use in supermarkets, retail establishments, institutions, restaurants and food service operations as they provide a visual separation, sound barrier and thermal separation. The door is designed to comply with all USDA sanitation requirements and is NSF approved. The corrosion resistant panel is ideal for wash down applications as it has no gaps or joint seams. The total width of the light duty traffic doors are 1½" thick.

New

MODEL NUMBER	DESCRIPTION	SIZE (W x H)	WEIGHT (POUND)
LDSW-37	SINGLE DOOR PANEL	3' x 7'	71
LDSW-57	DOUBLE PANEL DOOR	5' x 7'	120
LDSW-58	DOUBLE PANEL DOOR	5' x 8'	136
LDSW-67	DOUBLE PANEL DOOR	6' x 7'	142
LDSW-68	DOUBLE PANEL DOOR	6' x 8'	164
LDSW-88	DOUBLE PANEL DOOR	8' x 8'	188



Heavy Duty Swinging Traffic Doors

This multi-purpose lightweight door is tough enough to take the abuse of personnel, stock carts and motorized pallet jacks. The door panels are constructed with 1/8" thick rotationally molded cross-linked polyethylene outer shell and foamed-in-place Non-CFC urethane foam core. The panels are corrosion resistant, making it ideal for wash down applications as it has no gaps or joint seams. The door comes standard with 24" black bumpers on both sides of the door. Double acting V-cam hinging system operates smoothly and is virtually maintenance free with its permanently lubricated needle bearing roller assembly. There is a 1/8" thick polycarbonate window with black aluminum frame is recessed a minimum of 1/8" from the face of the panel to protect the window's surface from abrasion caused by passing loads, making the panels 1 7/8" thick.

New

MODEL NUMBER	DESCRIPTION	SIZE (W x H)	WEIGHT (POUND)
HDSW-37	SINGLE DOOR PANEL	3' x 7'	73
HDSW-57	DOUBLE PANEL DOOR	5' x 7'	128
HDSW-58	DOUBLE PANEL DOOR	5' x 8'	140
HDSW-67	DOUBLE PANEL DOOR	6' x 7'	145
HDSW-68	DOUBLE PANEL DOOR	6' x 8'	160
HDSW-88	DOUBLE PANEL DOOR	8' x 8'	200



Industrial Sliding Doors

Sliding Industrial Service Door Systems offer options that will satisfy almost any non-labeled sliding door application, including warehouse doors, doors with high wind load, or wall openings that provide access to oversized manufacturing equipment. These models incorporate modular panel construction with a resin impregnated Kraft honeycomb core securely bonded to 18 gauge cold rolled face sheets and utilize 18 gauge interior channels. The ISD series is an economical manual sliding door system. Heavy-duty hardware is available for large openings or motorized doors.

New

MODEL NUMBER	DESCRIPTION	SIZE (W x H)	COLOR	WEIGHT (POUND)
ISD-88	BI-PARTING	8' x 8'	PRIMED SILVER	891
ISD-1010	BI-PARTING	8' x 10'	PRIMED SILVER	1238
ISD-1212	BI-PARTING	12' x 12'	PRIMED SILVER	1631





series D-150



**DOCK SEAL & SHELTER
SURVEY SHEET IS
ON PAGE A42**

Dock Seals

The superior 36 oz. nylon reinforced vinyl facing has a higher tear strength than equivalent weight hypalon. The chemically sealed ends prevent moisture infiltration. It is mounted on and bonded to a durable wolmanized wood and contains a full height air escape tunnel. The unit consists of a three (3) piece construction (12" high; sides - beveled sides with 9½" width at the wall and 12" width at the face) and a through the wall installation kit that is included. 5" maximum compression is recommended. Application with a flush dock to building in conjunction with an Edge-O-Dock use a twenty (20) inch projection Dock Seal. To ensure proper size complete and fax the survey sheet shown on page A42. Units are non-returnable.

MODEL NUMBER	PROJECTION	OVERALL HEIGHT	OVERALL WIDTH	WEIGHT (POUND)
DOOR SIZE 8 FEET WIDE x 8 FEET HIGH				
D-150-10	10"	108"	120"	212
D-150-11	11"	108"	120"	214
D-150-12	12"	108"	120"	216
D-150-13	13"	108"	120"	218
D-150-14	14"	108"	120"	219
D-150-15	15"	108"	120"	220
D-150-16	16"	108"	120"	221
D-150-17	17"	108"	120"	222
D-150-18	18"	108"	120"	249
D-150-19	19"	108"	120"	251
D-150-20*	20"	108"	120"	252

*USE IN CONJUNCTION WITH EDGE-O-DOCK LEVELER



series D-350

MODEL NUMBER	PROJECTION	OVERALL HEIGHT	OVERALL WIDTH	WEIGHT (POUND)
DOOR SIZE 8 FEET WIDE x 9 FEET HIGH				
D-350-10	10"	120"	120"	216
D-350-11	11"	120"	120"	218
D-350-12	12"	120"	120"	220
D-350-13	13"	120"	120"	225
D-350-14	14"	120"	120"	237
D-350-15	15"	120"	120"	243
D-350-16	16"	120"	120"	248
D-350-17	17"	120"	120"	250
D-350-18	18"	120"	120"	264
D-350-19	19"	120"	120"	270
D-350-20*	20"	120"	120"	275

*USE IN CONJUNCTION WITH EDGE-O-DOCK LEVELER



series D-150/650

Dock Seal/Shelter Combinations

The Dock Seal/Shelter Combination is used with a 96"W x 120"H door. The top header is constructed of wolmanized lumber and is built with a slope to allow for water run-off. Header measures 114"W with a 30"L drop curtain. Side (verticals) measure 120" tall and contain high density foam mounted to treated lumber. The verticals are mounted on wooden boards (the face of the vertical measures 12"W and tapers to 9½" at wall) allowing wall mounting down the length of the vertical pieces. Application with flush dock to building in conjunction with an Edge-O-Dock use a 20" projection Dock Seal. To ensure proper size complete and fax the survey sheet shown on page A42. Units are non-returnable.

- Effective sealing action with full height access.
- This versatile unit utilizes seal sides and a shelter top.



**DOCK SEAL & SHELTER
SURVEY SHEET IS
ON PAGE A42**

MODEL NUMBER	PROJECTION	OVERALL HEIGHT	OVERALL WIDTH	WEIGHT (POUND)
DOOR SIZE 8 FEET WIDE x 10 FEET HIGH				
D-150/650-10	10"	126"	114"	271
D-150/650-11	11"	126"	114"	278
D-150/650-12	12"	126"	114"	285
D-150/650-13	13"	126"	114"	287
D-150/650-14	14"	126"	114"	290
D-150/650-15	15"	126"	114"	293
D-150/650-16	16"	126"	114"	296
D-150/650-17	17"	126"	114"	298
D-150/650-18	18"	126"	114"	299
D-150/650-19	19"	126"	114"	302
D-150/650-20*	20"	126"	114"	305

*USE IN CONJUNCTION WITH EDGE-O-DOCK LEVELER

Dock Shelters

The Dock Shelter is used with doors up to 10'W x 10'H. The dock shelter reduces oversized doors to match truck openings. The long wear fabric is highly resistant to abrasion and tearing. Fiberglass staves are sewn into the flaps. Seal is formed along the sides and top of trailer when the vertical and top panels are pushed inward by the trailer. Recommend minimum 10" trailer penetration for a good seal. Supporting structure is made of 2" x 4" wolmanized lumber. The top header piece measures 132"W and contains a drop curtain which measures 36"H. Two vertical pieces measure 126" tall with vertical flaps measuring 21"W. When installed, the shelter will close the door opening down to 90"W x 90"H (between flaps). Includes two yellow steel guide protectors and foam-filled corner pads for extra sealing action. To ensure proper size complete and fax the survey sheet shown on page A42. Units are non-returnable.



DOCK SEAL & SHELTER SURVEY SHEET IS ON PAGE A42

MODEL NUMBER	PROJECTION	OVERALL HEIGHT	OVERALL WIDTH	WEIGHT (POUND)
DOOR SIZE 8 FEET WIDE x 8 FEET HIGH to 10 FEET WIDE x 10 FEET HIGH				
D-750-18	18"	126"	132"	418
D-750-24	24"	126"	132"	478
D-750-30	30"	126"	132"	518
D-750-36	36"	126"	132"	563

Retractable Dock Shelter

The Retractable Dock Shelter fits up to a 120"W x 120"H door. Independent spring loaded scissor mechanism allows shelter to retract with the trailer keeping the shelter square. The design also eliminates the need for rigid steel guide protectors. The reinforced 40 oz. black vinyl-coated nylon flaps close the opening down to 90"W x 90"H. The 36" header curtain has armor pleats for extended wear. Shelter is black with aluminum edge trim. Optional Draft Pads, model D-520-24-DP, help prevent air from coming up underneath the dock flaps. To ensure proper size complete and fax the survey sheet shown on page A42. Units are non-returnable.



MODEL NUMBER	PROJECTION	OVERALL HEIGHT	OVERALL WIDTH	WEIGHT (POUND)
D-520-24	24"	132"	132"	590
D-520-24-DP	DRAFT PADS, 24" PROJECTION (SOLD PER PAIR)			9

Dock Seal Draft Blocker

Designed for blocking drafts between dock seals and dock levels. Compressible foam provides sealing action in all types of irregular gaps. Top carrying handles for easy removal. Air vent allows bag to return to original shape. Grommets for tether attachment (not included). Filled with foam for compressibility. Black vinyl construction with yellow stripes.



MODEL NUMBER	OVERALL WIDTH	OVERALL LENGTH	OVERALL HEIGHT	WEIGHT (POUND)
DRAFT-18	18"	12"	9"	6
DRAFT-24	24"	12"	9"	9
DRAFT-36	36"	12"	9"	12



DOCK SEAL AND SHELTER OPTIONS	
MODEL NUMBER	DESCRIPTION
D-FHPFS	Full height pleats & full height guide stripes for Seals and Shelters
D-FHPS	
D-AP	
D-54OZ	54 Ounce Material - Face Only
D-18H	18" Header
D-SV	Sloped Verticals
D-BBF	Bottom Bun
D-GS	Full Height Guide Stripes
D-12F	12" Flap
D-KIT	Optional six piece vinyl patch material, including glue and instructions

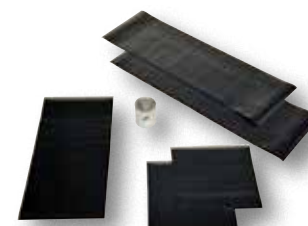

REPAIR KIT • model D-KIT





STANDARD MATERIAL WORKS IN CONDITIONS -10° TO 140°F

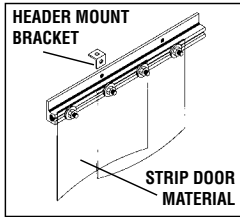

Vinyl Strip Doors

Vinyl Strip Doors help control noise, dust, fumes, and smoke while minimizing drafts, reducing illnesses, and accidents. The strip doors offer visual clarity without sacrificing safety and the fire resistant material is self-extinguishing. The simple low cost design is easy to maintain, while reducing heating and cooling costs. Standard material meets USDA Requirements. All doors are shipped pre-assembled and ready for installation. Installation hardware not included. Custom door sizes and material available, contact factory.

- Ribbed Material (8" & 12")
- Low Temperature Material (-50°F) (8" & 12")
- Bronze Weld Screen Material (8" & 12")
- Orange Opaque Material (6", 8", 12" & 16")



**CUT TO ORDER
NON-RETURNABLE**



HEADER MOUNT / STANDARD OVERLAP				
MODEL NUMBER	DOOR SIZE (W x H)	STRIP WIDTH	STRIP THICKNESS	WEIGHT (POUND)
TG-600-S-H-96-96	96" x 96"	6"	0.06"	
TG-600-S-H-96-108	96" x 108"	6"	0.06"	
TG-600-S-H-108-120	108" x 120"	6"	0.06"	
TG-600-S-H-120-120	120" x 120"	6"	0.06"	
TG-600-S-H-120-144	120" x 144"	6"	0.06"	
TG-600-S-H-144-144	144" x 144"	6"	0.06"	
TG-800-S-H-96-96	96" x 96"	8"	0.08"	
TG-800-S-H-96-108	96" x 108"	8"	0.08"	
TG-800-S-H-108-120	108" x 120"	8"	0.08"	
TG-800-S-H-120-120	120" x 120"	8"	0.08"	
TG-800-S-H-120-144	120" x 144"	8"	0.08"	
TG-800-S-H-144-144	144" x 144"	8"	0.08"	
TG-1200-S-H-96-96	96" x 96"	12"	0.12"	
TG-1200-S-H-96-108	96" x 108"	12"	0.12"	
TG-1200-S-H-108-120	108" x 120"	12"	0.12"	
TG-1200-S-H-120-120	120" x 120"	12"	0.12"	
TG-1200-S-H-120-144	120" x 144"	12"	0.12"	
TG-1200-S-H-144-144	144" x 144"	12"	0.12"	
TG-1600-S-H-96-96	96" x 96"	16"	0.16"	
TG-1600-S-H-96-108	96" x 108"	16"	0.16"	
TG-1600-S-H-108-120	108" x 120"	16"	0.16"	
TG-1600-S-H-120-120	120" x 120"	16"	0.16"	
TG-1600-S-H-120-144	120" x 144"	16"	0.16"	
TG-1600-S-H-144-144	144" x 144"	16"	0.16"	

HEADER MOUNT / FULL OVERLAP				
MODEL NUMBER	DOOR SIZE (W x H)	STRIP WIDTH	STRIP THICKNESS	WEIGHT (POUND)
TG-600-F-H-96-96	96" x 96"	6"	0.06"	
TG-600-F-H-96-108	96" x 108"	6"	0.06"	
TG-600-F-H-108-120	108" x 120"	6"	0.06"	
TG-600-F-H-120-120	120" x 120"	6"	0.06"	
TG-600-F-H-120-144	120" x 144"	6"	0.06"	
TG-600-F-H-144-144	144" x 144"	6"	0.06"	
TG-800-F-H-96-96	96" x 96"	8"	0.08"	
TG-800-F-H-96-108	96" x 108"	8"	0.08"	
TG-800-F-H-108-120	108" x 120"	8"	0.08"	
TG-800-F-H-120-120	120" x 120"	8"	0.08"	
TG-800-F-H-120-144	120" x 144"	8"	0.08"	
TG-800-F-H-144-144	144" x 144"	8"	0.08"	
TG-1200-F-H-96-96	96" x 96"	12"	0.12"	
TG-1200-F-H-96-108	96" x 108"	12"	0.12"	
TG-1200-F-H-108-120	108" x 120"	12"	0.12"	
TG-1200-F-H-120-120	120" x 120"	12"	0.12"	
TG-1200-F-H-120-144	120" x 144"	12"	0.12"	
TG-1200-F-H-144-144	144" x 144"	12"	0.12"	
TG-1600-F-H-96-96	96" x 96"	16"	0.16"	
TG-1600-F-H-96-108	96" x 108"	16"	0.16"	
TG-1600-F-H-108-120	108" x 120"	16"	0.16"	
TG-1600-F-H-120-120	120" x 120"	16"	0.16"	
TG-1600-F-H-120-144	120" x 144"	16"	0.16"	
TG-1600-F-H-144-144	144" x 144"	16"	0.16"	

WALL MOUNT / STANDARD OVERLAP				
MODEL NUMBER	DOOR SIZE (W x H)	STRIP WIDTH	STRIP THICKNESS	WEIGHT (POUND)
TG-600-S-W-96-96	96" x 96"	6"	0.06"	
TG-600-S-W-96-108	96" x 108"	6"	0.06"	
TG-600-S-W-108-120	108" x 120"	6"	0.06"	
TG-600-S-W-120-120	120" x 120"	6"	0.06"	
TG-600-S-W-120-144	120" x 144"	6"	0.06"	
TG-600-S-W-144-144	144" x 144"	6"	0.06"	
TG-800-S-W-96-96	96" x 96"	8"	0.08"	
TG-800-S-W-96-108	96" x 108"	8"	0.08"	
TG-800-S-W-108-120	108" x 120"	8"	0.08"	
TG-800-S-W-120-120	120" x 120"	8"	0.08"	
TG-800-S-W-120-144	120" x 144"	8"	0.08"	
TG-800-S-W-144-144	144" x 144"	8"	0.08"	
TG-1200-S-W-96-96	96" x 96"	12"	0.12"	
TG-1200-S-W-96-108	96" x 108"	12"	0.12"	
TG-1200-S-W-108-120	108" x 120"	12"	0.12"	
TG-1200-S-W-120-120	120" x 120"	12"	0.12"	
TG-1200-S-W-120-144	120" x 144"	12"	0.12"	
TG-1200-S-W-144-144	144" x 144"	12"	0.12"	
TG-1600-S-W-96-96	96" x 96"	16"	0.16"	
TG-1600-S-W-96-108	96" x 108"	16"	0.16"	
TG-1600-S-W-108-120	108" x 120"	16"	0.16"	
TG-1600-S-W-120-120	120" x 120"	16"	0.16"	
TG-1600-S-W-120-144	120" x 144"	16"	0.16"	
TG-1600-S-W-144-144	144" x 144"	16"	0.16"	

WALL MOUNT / FULL OVERLAP				
MODEL NUMBER	DOOR SIZE (W x H)	STRIP WIDTH	STRIP THICKNESS	WEIGHT (POUND)
TG-600-F-W-96-96	96" x 96"	6"	0.06"	
TG-600-F-W-96-108	96" x 108"	6"	0.06"	
TG-600-F-W-108-120	108" x 120"	6"	0.06"	
TG-600-F-W-120-120	120" x 120"	6"	0.06"	
TG-600-F-W-120-144	120" x 144"	6"	0.06"	
TG-600-F-W-144-144	144" x 144"	6"	0.06"	
TG-800-F-W-96-96	96" x 96"	8"	0.08"	
TG-800-F-W-96-108	96" x 108"	8"	0.08"	
TG-800-F-W-108-120	108" x 120"	8"	0.08"	
TG-800-F-W-120-120	120" x 120"	8"	0.08"	
TG-800-F-W-120-144	120" x 144"	8"	0.08"	
TG-800-F-W-144-144	144" x 144"	8"	0.08"	
TG-1200-F-W-96-96	96" x 96"	12"	0.12"	
TG-1200-F-W-96-108	96" x 108"	12"	0.12"	
TG-1200-F-W-108-120	108" x 120"	12"	0.12"	
TG-1200-F-W-120-120	120" x 120"	12"	0.12"	
TG-1200-F-W-120-144	120" x 144"	12"	0.12"	
TG-1200-F-W-144-144	144" x 144"	12"	0.12"	
TG-1600-F-W-96-96	96" x 96"	16"	0.16"	
TG-1600-F-W-96-108	96" x 108"	16"	0.16"	
TG-1600-F-W-108-120	108" x 120"	16"	0.16"	
TG-1600-F-W-120-120	120" x 120"	16"	0.16"	
TG-1600-F-W-120-144	120" x 144"	16"	0.16"	
TG-1600-F-W-144-144	144" x 144"	16"	0.16"	

Dock Bug Screen Doors 115V 1-PHASE STANDARD

Improve employee comfort while increasing productivity. It is used at loading docks, garages, and food processing facilities. Keeps birds, flies, moths, mosquitoes, wasps, and other insects out while providing fresh air ventilation, sunlight, and increased security. It is constructed of durable, all weather vinyl coated polyester that is fire retardant as well as mildew and UV resistant. Easy to install. Operation involves a simple manual roller and track system that allows the screen to slide smoothly from side to side, or easy roll up and down system that is available spring loaded or motorized. Standard color is blue with yellow pockets.

Colors Available

Add color to suffix of model number.
Color shown may differ from actual color.
Consult factory for each color.

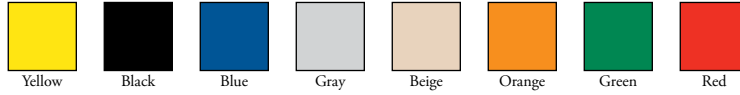

MANUAL ROLLER AND TRACK SYSTEM				
MODEL NUMBER	OPERATION	DOOR SIZE (W x H)	MOUNT	WEIGHT (POUND)
DBS-88-H	SLIDING	8' x 8'	IN JAMB	100
DBS-810-H	SLIDING	8' x 10'	IN JAMB	115
DBS-1010-H	SLIDING	10' x 10'	IN JAMB	125
DBS-88-W	SLIDING	8' x 8'	MOUNTS ON INSIDE WALL	115
DBS-810-W	SLIDING	8' x 10'	MOUNTS ON INSIDE WALL	130
DBS-1010-W	SLIDING	10' x 10'	MOUNTS ON INSIDE WALL	140

ROLL UP AND DOWN SYSTEM				
MODEL NUMBER	OPERATION	DOOR SIZE (W x H)	MOUNT	WEIGHT (POUND)
DBS-88-SL-H	SPRING LOAD ROLL UP	8' x 8'	IN JAMB	100
DBS-810-SL-H	SPRING LOAD ROLL UP	8' x 10'	IN JAMB	115
DBS-1010-SL-H	SPRING LOAD ROLL UP	10' x 10'	IN JAMB	125
DBS-88-ITM-H	IN-TUBE MOTORIZED	8' x 8'	IN JAMB	110
DBS-810-ITM-H	IN-TUBE MOTORIZED	8' x 10'	IN JAMB	125
DBS-1010-ITM-H	IN-TUBE MOTORIZED	10' x 10'	IN JAMB	135

Dock Bug Wire Mesh Door 115V 1-PHASE STANDARD

Stop trespassing, and at the same time, let in natural sunlight and fresh air with the Wire Mesh Dock Door. Doors are made with a 15 gauge aluminum with a 1/2" coil wire mesh, and heavy duty extruded aluminum "C" channel guide track which is 1.25" wide x 4" deep. Safety yellow and black strips are standard on the interior edge of the panel. Horizontal stiffeners are constructed with 3/4" fiberglass wind load rods and are inserted into specially constructed coils for horizontal stability, visibility, and increased safety.

MODEL NUMBER	OPERATION	DOOR SIZE (W x H)	MOUNT	WEIGHT (POUND)
DWM-88-ITM-W	IN-TUBE MOTORIZED	8' x 8'	WALL	150
DWM-810-ITM-W	IN-TUBE MOTORIZED	8' x 10'	WALL	165
DWM-1010-ITM-W	IN-TUBE MOTORIZED	10' x 10'	WALL	175

Construction Chutes

Polyethylene trash chutes are the choice of suppliers & contractors throughout North America. Superb ease-of-use and durability provide a quick, clean, & safe solution. Our designs have been perfected to provide you with the right tool for debris removal. Ideal for; Builders, Roofers, Scaffolders, Masons, Demo Contractors, Supply Houses, Rental Stores, and Renovators. These tapered tubes attach quickly & easily to one another using built-in cable assemblies. Entry doors allow debris to be cleared from any floor level. CC-30-MC is used for heavier debris, such as concrete, and CC-30-TC is used for lighter debris, such as shingles. Use Basic Support Frame and Parapet Outrigger when supporting from top of roof. Other supports available, contact factory.

MODEL NUMBER	DESCRIPTION	OVERALL SIZE (D x L x H)	WEIGHT (POUND)
CC-30-TH	TOP HOPPER	30" x 48" x 28"	150
CC-30-MC	MEDIUM GAUGE CHUTE	32" x 48" x 48"	96
CC-30-TC	THIN GAUGE CHUTE	48" x 96" x 42"	90
CC-30-ED	ENTRY DOOR	29" x 48" x 28"	190
CC-30-SF	BASIC SUPPORT FRAME		69
CC-30-PO	PARAPET OUTRIGGER (to mount to above support)		91



CURTAIN SLIDES SMOOTHLY FROM SIDE TO SIDE



CURTAIN ROLLS UP AND DOWN. SPECIAL COLOR SHOWN.

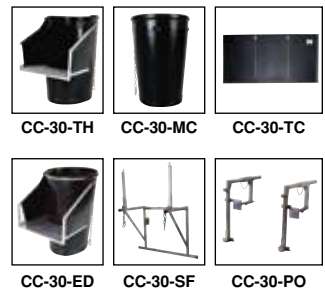



New

model YR-16-7236

Steel Yard Ramps

Quickly load and unload trucks, trailers, and rail cars from ground level when no freight dock exists. Increase productivity while reducing material handling costs. Great for construction sites. A manual two-speed hand crank for easy one person height adjustment offers a service range of 45" to 62". Available in 30 foot of straight ramp or 36 foot overall length; 30 foot of straight ramp and 6 foot level off. Standard features include: 8 5/8" steel wheels, positive traction open steel grating, safety locking chains, 4" high steel safety curbs, rubber bumpers, 14" usable overlap lip, tow bar pocket, and welded steel construction. Painted neutral earth-tone brown. All units must ship flatbed truck.



MANUAL HAND CRANK AND 8-5/8" STEEL WHEELS



SAFETY LOCKING CHAINS WITH 14" USABLE OVERLAP LIP



TOW BAR POCKET INCLUDED



Video Available

PORTABLE STEEL YARD RAMPS

MODEL NUMBER	UNIFORM CAPACITY	OVERALL** RAMP WIDTH	USABLE RAMP WIDTH	LENGTH (FEET)	WEIGHT (POUND)
YR-16-7230	16,000 lb.	72"	66"	30	4625
YR-16-8430	16,000 lb.	84"	78"	30	5375
YR-16-7236	16,000 lb.	72"	66"	36	5925
YR-16-8436	16,000 lb.	84"	78"	36	6250
YR-20-7330	20,000 lb.	73"	66"	30	5275
YR-20-8530	20,000 lb.	85"	78"	30	5852
YR-20-7336	20,000 lb.	73"	66"	36	6275
YR-20-8536	20,000 lb.	85"	78"	36	6975
YR-25-7330	25,000 lb.	73"	66"	30	5450
YR-25-8530	25,000 lb.	85"	78"	30	6000
YR-25-7336	25,000 lb.	73"	66"	36	6475
YR-25-8536	25,000 lb.	85"	78"	36	7175
YR-30-7330	30,000 lb.	73"	66"	30	5600
YR-30-8530	30,000 lb.	85"	78"	30	6175
YR-30-7336	30,000 lb.	73"	66"	36	6650
YR-30-8536	30,000 lb.	85"	78"	36	7350

**ADD 17-3/8" TO OVERALL RAMP WIDTH FOR MAXIMUM OVERALL WIDTH (18-3/8" FOR 16K UNITS). THIS INCLUDES LANDING GEAR AND CRANK MECHANISM.

PORTABLE STEEL YARD RAMPS WITH MECHANICAL EDGE-O-DOCK

MODEL NUMBER	UNIFORM CAPACITY	OVERALL WIDTH	USABLE WIDTH	LENGTH (FEET)	WEIGHT (POUND)
YRD-16-7236-M	16,000 lb.	72"	66"	36	6495
YRD-16-8436-M	16,000 lb.	84"	78"	36	6775
YRD-20-7336-M	20,000 lb.	73"	66"	36	6000
YRD-20-8536-M	20,000 lb.	85"	78"	36	7500
YRD-25-7336-M	25,000 lb.	73"	66"	36	7000
YRD-25-8536-M	25,000 lb.	85"	78"	36	7700
YRD-30-7336-M	30,000 lb.	73"	66"	36	7175
YRD-30-8536-M	30,000 lb.	85"	78"	36	7875

LEVELER IS 64" WIDE ON 72" & 73" MODELS AND 75" WIDE ON 84" & 85" MODELS

PORTABLE STEEL YARD RAMPS WITH HAND PUMP HYDRAULIC EDGE-O-DOCK**

MODEL NUMBER	UNIFORM CAPACITY	OVERALL WIDTH	USABLE WIDTH	LENGTH (FEET)	WEIGHT (POUND)
YRD-16-7236-H	16,000 lb.	72"	66"	36	6495
YRD-16-8436-H	16,000 lb.	84"	78"	36	6775
YRD-20-7336-H	20,000 lb.	73"	66"	36	6000
YRD-20-8536-H	20,000 lb.	85"	78"	36	7500
YRD-25-7336-H	25,000 lb.	73"	66"	36	7000
YRD-25-8536-H	25,000 lb.	85"	78"	36	7700
YRD-30-7336-H	30,000 lb.	73"	66"	36	7175
YRD-30-8536-H	30,000 lb.	85"	78"	36	7875

LEVELER IS 64" WIDE ON 72" & 73" MODELS AND 75" WIDE ON 84" & 85" MODELS

YARD RAMP OPTIONS CAN BE FOUND ON PAGE A16

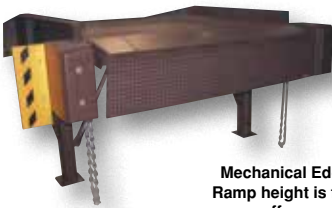

Mechanical Edge-Of-Dock Leveler. Ramp height is fixed at 50". Leveler offers service range of +/- 5".

STATIONARY STEEL YARD RAMPS WITH EDGE-O-DOCK

MODEL NUMBER	UNIFORM CAPACITY	OVERALL WIDTH	USABLE WIDTH	LENGTH (FEET)	WEIGHT (POUND)
MECHANICAL EDGE-O-DOCK AT TRUCK END					
YRDS-16-7236-M	16,000 lb.	72"	66"	36	6275
YRDS-16-8536-M	16,000 lb.	85"	78"	36	6600
YRDS-20-8536-M	20,000 lb.	85"	78"	36	7325
HAND PUMP HYDRAULIC EDGE-O-DOCK AT TRUCK END					
YRDS-16-7236-H	16,000 lb.	72"	66"	36	6275
YRDS-16-8536-H	16,000 lb.	85"	78"	36	6600
YRDS-20-8536-H	20,000 lb.	85"	78"	36	7325

LEVELER IS 66" WIDE ON 72" & 73" MODELS AND 72" WIDE ON 84" & 85" MODELS



Stationary ramps, series YRDS, include an Edge-Of-Dock Leveler at the truck end. Ramp height is fixed at 50". Leveler offers service range of +/- 5".

Aluminum Yard Ramps

Portable Aluminum Yard Ramps have a unique design that allows one person to position the ramp, adjust its service height, and load or unload trailers from ground level. Available with steel or rust resistant aluminum grating. Standard features: Hand pump hydraulic lift, safety pressure relief valve, 18" x 5" mold-on-rubber tires, 4" high curbs, service range of 45" to 62", anchor chains, and tow bar pocket. Yard Ramps ship flatbed truck.



ALUMINUM GRATING series AY

ALUMINUM YARD RAMP WITH ALUMINUM GRATING					
MODEL NUMBER	UNIFORM CAPACITY	OVERALL** RAMP WIDTH	USABLE RAMP WIDTH	LENGTH (FEET)	WEIGHT (POUND)
AY-167230	16,000 lb.	74"	66"	30	2783
AY-168430	16,000 lb.	86"	78"	30	3150
AY-169330	16,000 lb.	95"	87"	30	3465
AY-167236-L	16,000 lb.	74"	66"	36	3360
AY-168436-L	16,000 lb.	86"	78"	36	3728
AY-169336-L	16,000 lb.	95"	87"	36	3990
AY-207230	20,000 lb.	74"	66"	30	2888
AY-208430	20,000 lb.	86"	78"	30	3255
AY-209330	20,000 lb.	95"	87"	30	3570
AY-207236-L	20,000 lb.	74"	66"	36	3465
AY-208436-L	20,000 lb.	86"	78"	36	3833
AY-209336-L	20,000 lb.	95"	87"	36	4095
AY-257230	25,000 lb.	74"	66"	30	2940
AY-258430	25,000 lb.	86"	78"	30	3308
AY-259330	25,000 lb.	95"	87"	30	3675
AY-257236-L	25,000 lb.	74"	66"	36	3578
AY-258436-L	25,000 lb.	86"	78"	36	3885
AY-259336-L	25,000 lb.	95"	87"	36	4200
AY-307230	30,000 lb.	74"	66"	30	3092
AY-308430	30,000 lb.	86"	78"	30	3360
AY-307236-L	30,000 lb.	74"	66"	36	3570
AY-308436-L	30,000 lb.	86"	78"	36	3938



18" x 5" MOLD-ON-RUBBER TIRES ARE STANDARD



13 1/2" USABLE LIP SUPPORT EDGE FITS INTO TRAILER OR BUILDING SAFETY CHAINS STANDARD

ALUMINUM YARD RAMP WITH STEEL GRATING					
MODEL NUMBER	UNIFORM CAPACITY	OVERALL WIDTH	USABLE WIDTH	LENGTH (FEET)	WEIGHT (POUND)
SY-167230	16,000 lb.	74"	66"	30	3518
SY-168430	16,000 lb.	86"	78"	30	4043
SY-169330	16,000 lb.	95"	87"	30	4515
SY-167236-L	16,000 lb.	74"	66"	36	4305
SY-168436-L	16,000 lb.	86"	78"	36	4830
SY-169336-L	16,000 lb.	95"	87"	36	5303
SY-207230	20,000 lb.	74"	66"	30	3623
SY-208430	20,000 lb.	86"	78"	30	4148
SY-209330	20,000 lb.	95"	87"	30	4620
SY-207236-L	20,000 lb.	74"	66"	36	4410
SY-208436-L	20,000 lb.	86"	78"	36	4935
SY-209336-L	20,000 lb.	95"	87"	36	5408
SY-257230	25,000 lb.	74"	66"	30	3675
SY-258430	25,000 lb.	86"	78"	30	4200
SY-259330	25,000 lb.	95"	87"	30	4725
SY-257236-L	25,000 lb.	74"	66"	36	4463
SY-258436-L	25,000 lb.	86"	78"	36	4988
SY-259336-L	25,000 lb.	95"	87"	36	5513
SY-307230	30,000 lb.	74"	66"	30	3728
SY-308430	30,000 lb.	86"	78"	30	4253
SY-307236-L	30,000 lb.	74"	66"	36	4515
SY-308436-L	30,000 lb.	86"	78"	36	5040

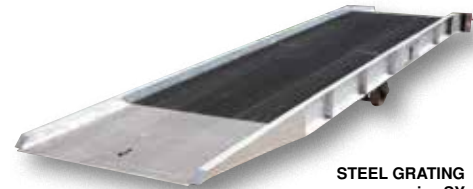

STEEL GRATING series SY



YARD RAMP OPTIONS CAN BE FOUND ON PAGE A16

Options for Yard Ramps



27" PNEUMATIC TIRES



HYDRAULIC HAND PUMP
model YR-HL

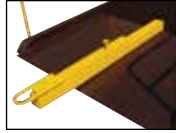

TOW BAR HITCH
model YR-TB-H



TOW BAR POCKET
model YR-TB-P



FORK LIFT
PICK-UP SLOTS
model YR-FS



NON-REMOVABLE
STEEL HANDRAIL
model YR-HDRL



GALVANIZED
GUARD RAIL
series YR-GR

STEEL YARD RAMP OPTIONS

MODEL NUMBER	DESCRIPTION	WEIGHT (POUND)
YR-HL	PNEUMATIC TIRE & HAND PUMP HYDRAULIC LIFT (5 MPH MAX. TOW SPEED) (NOT AVAILABLE ON YRD MODELS)	230
YR-HL-DC*	PNEUMATIC TIRE & 12V DC HYDRAULIC LIFT (5 MPH MAX. TOW SPEED) (NOT AVAILABLE ON YRD MODELS)	288
YR-FS	FORK LIFT PICKUP SLOTS (7½"W X 2½"H USABLE ON 24" CENTERS)	460
YR-TB-H	TOW BAR HITCH	145
YR-TB-P	TOW BAR POCKET	35
YR-GR-30	12" HIGH GUARD RAIL OPTION FOR 30 FEET RAMPS (BOTH SIDES)	456
YR-GR-36	12" HIGH GUARD RAIL OPTION FOR 36 FEET RAMPS (BOTH SIDES)	550
YR-HDRL	NON-REMOVABLE 42" HIGH STEEL HANDRAIL WITH 21" MIDRAIL (WELDED)	9/FT.
YR-RHDRL	REMOVABLE 42" HIGH STEEL HANDRAIL WITH 21" MIDRAIL	9/FT.
YR-RAHDRL	REMOVABLE 42" HIGH ALUMINUM HANDRAIL WITH 21" MIDRAIL	3/FT.
YR-DH	HOLES IN LIP TO LAG RAMP TO TOP OF DOCK	--

*INCLUDES ON-BOARD CHARGER



PNEUMATIC TIRES OPTION
Service Range will be 40" to 66"
model AY-PNTR



TOW BAR POCKET
model YR-TB-P

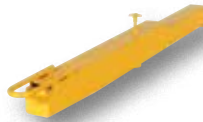

TOW BAR HITCH
model AY-TB-H



HAND PUMP
HYDRAULIC LIFT STANDARD

ALUMINUM YARD RAMP OPTIONS

MODEL NUMBER	DESCRIPTION	WEIGHT (POUND)
AYR-HL-DC	12V DC HYDRAULIC LIFT (INCLUDES ON-BOARD CHARGER)	50
AYR-TB-H	TOW BAR HITCH	145
AYR-TB-P	TOW BAR POCKET	35
AYR-GR-30	12" HIGH GUARD RAIL OPTION FOR 30 FEET RAMPS	456
AYR-GR-36	12" HIGH GUARD RAIL OPTION FOR 36 FEET RAMPS	550
AY-AHDRL	NON-REMOVABLE 42" HIGH ALUMINUM HANDRAIL WITH 21" MIDRAIL (WELDED)	3/FT.
AY-RAHDRL	REMOVABLE 42" HIGH ALUMINUM HANDRAIL WITH 21" MIDRAIL	3/FT.
AY-RHDRL	REMOVABLE 42" HIGH STEEL HANDRAIL WITH 21" MIDRAIL	9/FT.
AYR-CRB6	6" CURB HEIGHT	--
AYR-YEL	YELLOW SAFETY CURBS	--
AY-PNTR	20½" x 8" PNEUMATIC TIRE OPTION	--
AYR-DH	HOLES IN LIP TO LAG RAMP TO TOP OF DOCK	--



Steel Railroad Dockboards

- Auto Drop Locks (add 13" to overall width)
- Steel Rectangular Board
- Safety Curbs are 4" High
- Tread plate for Better Traction
- Pop-up Fork Lift Loops
- Overlap Style Plate (both ends)
- High Strength Cross Traffic
- Structural Steel Support Beams

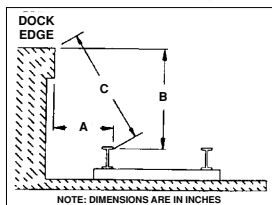

The Steel Railroad Dockboard has a rectangular-style with a deck that is made of high-strength raised diamond steel treadplate with structural steel support beams for high strength cross traffic. Treadplate provides increased traction; overlap-style lip on both dock and rail car ends gives maximum versatility. Fork truck pop-up loops are built into deck - automatically pop-up when board is set on floor. Automatic drop-locks on both sides of board are designed to keep the board in place between dock and rail car. Non-returnable. *Contact factory for pricing.*

Aluminum Hand Truck Dockplates

This Aluminum Hand Truck Dockplate is designed for use with two (2) wheel hand trucks. It is a convenient, safe, and an easy way to access loading docks from trucks. This dockplate is lightweight and easily transported by just one person. The tread plate surface ensures skid-resistant safe traction and the locking legs secure the plate for safe loading and unloading. Complete with bolt-on zinc plated carrying handles and locking legs.



48 Hours
to Ship

DESIGNED FOR USE
WITH TWO WHEEL
HAND TRUCKS
(not included)

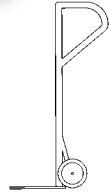

			1/4" PLATE THICKNESS			5/16" PLATE THICKNESS		
PLATE* WIDTH	PLATE LENGTH	HEIGHT DIFF.	MODEL NUMBER	NET WT. (POUND)	UNIFORM CAPACITY	MODEL NUMBER	NET WT. (POUND)	UNIFORM CAPACITY
30"	24"	3"	A-3024	28	500 lb.	AH-3024	31	700 lb.
30"	30"	4"	A-3030	33	500 lb.	AH-3030	35	700 lb.
30"	36"	5"	A-3036	40	500 lb.	AH-3036	45	700 lb.
30"	48"	7"	A-3048	44	500 lb.	AH-3048	53	700 lb.
36"	24"	3"	A-3624	32	500 lb.	AH-3624	37	700 lb.
36"	30"	4"	A-3630	37	500 lb.	AH-3630	43	700 lb.
36"	36"	5"	A-3636	46	500 lb.	AH-3636	54	700 lb.
36"	48"	7"	A-3648	55	500 lb.	AH-3648	63	700 lb.

*ADD 6" TO GET OVERALL WIDTH

Aluminum Economizer Dockplates

The Aluminum Economizer Dockplate is an economical way to speed up truck loading and unloading. Spans the opening between dock and trailer to allow pallet or hand trucks along with traffic to safely move in and out of the trailer. The dockplate is constructed of high strength, non-skid aluminum alloy tread plate. The lightweight design with bolt-on zinc plated legs and handles on each side makes portability easy. Locking legs for OSHA compliance. The bend or crown is 11° and located 9" from edge of dockplate. Not for use with fork trucks.

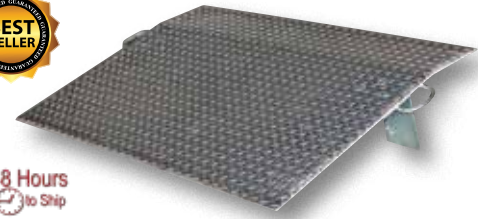

48 Hours
to Ship

			3/8" PLATE THICKNESS				1/2" PLATE THICKNESS			
PLATE* WIDTH	PLATE LENGTH	HEIGHT DIFF.	MODEL NUMBER	SHIPS VIA	NET WT. (POUND)	UNIFORM CAPACITY	MODEL NUMBER	SHIPS VIA	NET WT. (POUND)	UNIFORM CAPACITY
30"	24"	3"	E-3024	UPS	35	3,000 lb.	EH-3024	UPS	42	5,200 lb.
30"	30"	4"	E-3030	UPS	40	2,300 lb.	EH-3030	UPS	50	4,100 lb.
30"	36"	5"	E-3036	UPS	49	1,800 lb.	EH-3036	UPS	61	3,500 lb.
30"	48"	7"	E-3048	UPS	59	1,400 lb.	EH-3048	UPS	74	2,600 lb.
36"	24"	3"	E-3624	UPS	45	3,600 lb.	EH-3624	UPS	49	6,200 lb.
36"	30"	4"	E-3630	UPS	55	3,000 lb.	EH-3630	UPS	60	5,100 lb.
36"	36"	5"	E-3636	UPS	71	2,500 lb.	EH-3636	UPS	71	4,300 lb.
36"	48"	7"	E-3648	UPS	88	1,900 lb.	EH-3648	UPS	89	3,000 lb.
42"	24"	3"	E-4224	UPS	44	4,300 lb.	EH-4224	UPS	56	7,200 lb.
42"	30"	4"	E-4230	UPS	51	3,300 lb.	EH-4230	UPS	67	5,900 lb.
42"	48"	7"	E-4248	LTL	80	2,100 lb.	EH-4248	LTL	103	3,500 lb.
48"	24"	3"	E-4824	UPS	48	5,200 lb.	EH-4824	UPS	55	8,200 lb.
48"	30"	4"	E-4830	UPS	63	4,100 lb.	EH-4830	UPS	73	6,300 lb.
48"	36"	5"	E-4836	UPS	71	3,500 lb.	EH-4836	UPS	89	5,300 lb.
48"	42"	6"	E-4842	LTL	81	3,000 lb.	EH-4842	LTL	103	4,300 lb.
48"	48"	7"	E-4848	LTL	91	2,600 lb.	EH-4848	LTL	118	3,800 lb.
48"	54"	8"	E-4854	LTL	102	2,200 lb.	EH-4854	LTL	133	3,300 lb.
48"	60"	9"	E-4860	LTL	112	1,800 lb.	EH-4860	LTL	153	2,900 lb.
60"	24"	3"	E-6024	UPS	60	5,700 lb.	EH-6024	UPS	75	10,000 lb.
60"	30"	4"	E-6030	UPS	69	4,600 lb.	EH-6030	UPS	88	7,800 lb.
60"	36"	5"	E-6036	LTL	75	4,100 lb.	EH-6036	LTL	109	6,600 lb.
60"	42"	6"	E-6042	LTL	107	3,500 lb.	EH-6042	LTL	127	5,500 lb.
60"	48"	7"	E-6048	LTL	119	2,900 lb.	EH-6048	LTL	145	4,800 lb.
60"	54"	8"	E-6054	LTL	127	2,400 lb.	EH-6054	LTL	159	4,100 lb.
60"	60"	9"	E-6060	LTL	136	2,000 lb.	EH-6060	LTL	177	3,700 lb.
72"	24"	3"	E-7224	UPS	84	6,500 lb.	EH-7224	UPS	87	11,900 lb.
72"	30"	4"	E-7230	LTL	92	5,400 lb.	EH-7230	LTL	106	9,500 lb.
72"	36"	5"	E-7236	LTL	100	4,300 lb.	EH-7236	LTL	129	7,800 lb.
72"	48"	7"	E-7248	LTL	138	3,400 lb.	EH-7248	LTL	173	5,900 lb.

*OVERALL WIDTH IS PLATE WIDTH PLUS 6"

ALUMINUM DOCKPLATE OPTIONS • series A, AH, E, EH & AHTD	
MODEL NUMBER	DESCRIPTION
DPR-2616	Dock Plate Rack (A, AH, E & EH series only)
OHDL	No Handles
1HDL	One Handle
SDP	Smooth Deck Plate (Diamond Side Down)
SB	Special Bend or Location of Bend
SLL	Special Location of Legs
LHDL	Extra Pair of Legs, Handles & Hdwr.
ATC-12	Anti-Theft Chain (144")
TRADE	Trade in Allowance (FOB IN)



DOCK PLATE RACK
model DPR-2616



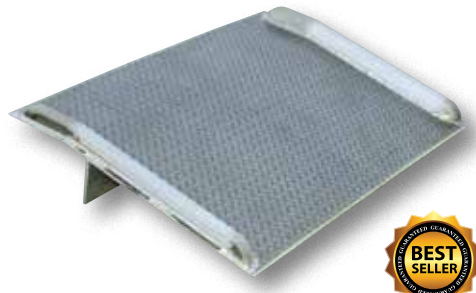

Aluminum Truck Dockboards (Welded Aluminum Curbs)

The Aluminum Truck Dockboard is engineered and built to maximize safety while handling heavy fork trucks and loads. The beveled edge is designed for smooth entry and exit. Locking legs prevent movement during loading and unloading operations. Locking legs are uneven to allow the dockboard to sit canted, while not in use, for easier pickup by fork trucks. Welded aluminum safety curbs prevent accidental runoffs and provide a visible driving lane. When using three-wheeled fork trucks order dockboard with capacity at least four-times the lifting capacity of fork truck. The width of the dockboard should be at least 15 (in.) wider than the load or equipment passing between the curbs. Bend is 11° and 9" from the edge and the legs are 12" from the edge. Manufactured in compliance with OSHA.

CAPACITY is based upon the heaviest type of equipment used plus the maximum load carried times the single axle rating of total load. Dynamic loading, driver tendencies, speed, and frequency of use must be considered. Steel (TS-series) dockboards recommended for high use docks.

EQUIPMENT	SINGLE AXLE RATING OF TOTAL LOAD
TWO-WHEEL HAND TRUCKS	100%
FOUR-WHEEL PLATFORM TRUCK - (NON-TILT)	50%
PALLET TRUCKS - HAND	75%
PALLET TRUCKS - ELECTRIC	66%
PLATFORM (SKID) TRUCKS - HAND - WALKIE	75%
PLATFORM (SKID) TRUCKS - ELECTRIC - WALKIE	66%
FORK TRUCKS - ELECTRIC WALKIE	90%
FORK TRUCKS - ELECTRIC RIDER	90%
FORK TRUCKS - GAS RIDER	90%

Use this guide for truck floor heights to determine the Height Differential from the truck bed to dock. (Numbers listed reference an empty truck.)

REFRIGERATED	54" to 61"
HEAVY TRAILERS	51" to 56"
HEAVY SEMI-TRAILERS	48" to 54"
LIGHT SEMI-TRAILERS	45" to 49"
LARGE SINGLE BED	42" to 50"
SMALL SINGLE BED	30"

Use first & second column of chart below to determine length of board.
 Rise/Run (x 100) = % of Grade.

UNIFORM CAPACITY			5,000 LBS.		6,000 LBS.		8,000 LBS.		10,000 LBS.	
Size Width- Length Inches	Ht. Difference 8 1/17% Inches	Ht. Difference 11 1/19% Inches	Model Number		Model Number		Model Number		Model Number	
			Net Wt. (Pound)	Net Wt. (Pound)	Net Wt. (Pound)	Net Wt. (Pound)	Net Wt. (Pound)	Net Wt. (Pound)		
54	36	4	BTA-05005436	79	BTA-06005436	73	BTA-08005436	112		
	48	5 1/2	BTA-05005448	98	BTA-06005448	109	BTA-08005448	118		
	60	7	BTA-05005460	124	BTA-06005460	134	BTA-08005460	149		
60	30	3	BTA-05006030	72	BTA-06006030	81	BTA-08006030	100	BTA-10006030	106
	36	4	BTA-05006036	82	BTA-06006036	91	BTA-08006036	110	BTA-10006036	123
	42	5	BTA-05006042	95	BTA-06006042	101	BTA-08006042	114	BTA-10006042	136
	48	5 1/2	BTA-05006048	105	BTA-06006048	120	BTA-08006048	126	BTA-10006048	173
	54	6	BTA-05006054	123	BTA-06006054	132	BTA-08006054	151	BTA-10006054	194
	60	7	BTA-05006060	133	BTA-06006060	144	BTA-08006060	166	BTA-10006060	197
	66	8	BTA-05006066	156	BTA-06006066	156	BTA-08006066	172	BTA-10006066	215
	72	8 1/2	BTA-05006072	163	BTA-06006072	164	BTA-08006072	191	BTA-10006072	251
66	36	4	BTA-05006636	96	BTA-06006636	150	BTA-08006636	112	BTA-10006636	136
	48	5 1/2	BTA-05006648	116	BTA-06006648	208	BTA-08006648	125	BTA-10006648	208
	60	7	BTA-05006660	126	BTA-06006660	241	BTA-08006660	214	BTA-10006660	220
	72	8 1/2	BTA-05007230	85	BTA-06007230	81	BTA-08007230	120	BTA-10007230	126
72	36	4	BTA-05007236	92	BTA-06007236	91	BTA-08007236	145	BTA-10007236	161
	48	5 1/2	BTA-05007248	152	BTA-06007248	130	BTA-08007248	204	BTA-10007248	189
	60	7	BTA-05007260	195	BTA-06007260	200	BTA-08007260	212	BTA-10007260	247
	78	8 1/2	BTA-05007836	164	BTA-06007836	158	BTA-08007836	188	BTA-10007836	168
78	48	5 1/2	BTA-05007848	196	BTA-06007848	171	BTA-08007848	196	BTA-10007848	215
	60	7	BTA-05007860	228	BTA-06007860	186	BTA-08007860	206	BTA-10007860	276
	84	8 1/2	BTA-05008436	98	BTA-06008436	209	BTA-08008436	126	BTA-10008436	195
84	48	5 1/2	BTA-05008448	160	BTA-06008448	218	BTA-08008448	156	BTA-10008448	232
	60	7	BTA-05008460	212	BTA-06008460	235	BTA-08008460	188	BTA-10008460	250

UNIFORM CAPACITY			12,000 LBS.		15,000 LBS.		20,000 LBS.	
Size Width- Length Inches	Ht. Difference 8 1/17% Inches	Ht. Difference 11 1/19% Inches	Model Number		Model Number		Model Number	
			Net Wt. (Pound)	Net Wt. (Pound)	Net Wt. (Pound)	Net Wt. (Pound)		
60	30	3	BTA-12006030	106	BTA-15006030	132	BTA-20006030	154
	36	4	BTA-12006036	136	BTA-15006036	141	BTA-20006036	177
	48	5 1/2	BTA-12006048	196	BTA-15006048	180	BTA-20006048	206
	54	6	BTA-12006054	210	BTA-15006054	206	BTA-20006054	250
	60	7	BTA-12006060	215	BTA-15006060	229	BTA-20006060	278
	72	8 1/2	BTA-12006072	280	BTA-15006072	272	BTA-20006072	357
66	36	4	BTA-12006636	162	BTA-15006636	151	BTA-20006636	192
	48	5 1/2	BTA-12006648	204	BTA-15006648	210	BTA-20006648	213
	60	7	BTA-12006660	254	BTA-15006660	242	BTA-20006660	265
72	30	3	BTA-12007230	144	BTA-15007230	149	BTA-20007230	155
	36	4	BTA-12007236	156	BTA-15007236	162	BTA-20007236	195
	48	5 1/2	BTA-12007248	245	BTA-15007248	212	BTA-20007248	228
	60	7	BTA-12007260	315	BTA-15007260	269	BTA-20007260	326
78	72	8 1/2	BTA-12007272	355	BTA-15007272	386		
	36	4	BTA-12007836	195	BTA-15007836	213	BTA-20007836	235
	48	5 1/2	BTA-12007848	233	BTA-15007848	224	BTA-20007848	298
	60	7	BTA-12007860	273	BTA-15007860	390	BTA-20007860	326
84	72	8 1/2	BTA-12007872	355	BTA-15007872	423		
	36	4	BTA-12008436	228	BTA-15008436	232	BTA-20008436	244
	48	5 1/2	BTA-12008448	253	BTA-15008448	257	BTA-20008448	314
	60	7	BTA-12008460	267	BTA-15008460	321	BTA-20008460	390
72	8 1/2	BTA-12008472	375	BTA-15008472	372			



Aluminum Truck Dockboards with Steel Safety Curbs

The Aluminum Truck Dockboard with Steel Safety Curbs is designed for portability and safety. The deck is made of tough high strength aluminum diamond tread plate. The edges are beveled for smooth entry and exit. Safety curbs are coated yellow and are constructed of steel with cast tapered ends. Steel legs are bolted on for increased durability. Legs are located 12" from the beveled edge. The legs are canted for easier fork truck portability. The bend is 11° and 9" from the beveled edge. Manufactured in compliance with OSHA. When using three-wheeled fork trucks order dockboard with capacity at least four-times the lifting capacity of fork truck.



48 Hours
to Ship

UNIFORM CAPACITY			10,000 LBS.		15,000 LBS.		20,000 LBS.	
Size (Inches) Width x Length	Ht. Difference 11° / 19° Inches		MODEL NUMBER	WEIGHT (POUND)	MODEL NUMBER	WEIGHT (POUND)	MODEL NUMBER	WEIGHT (POUND)
60 36	5		TAS-10-6036	100	TAS-15-6036	107	TAS-20-6036	110
60 48	7		TAS-10-6048	129	TAS-15-6048	146	TAS-20-6048	165
60 60	10		TAS-10-6060	160	TAS-15-6060	204	TAS-20-6060	218
60 72	12		TAS-10-6072	220	TAS-15-6072	251	TAS-20-6072	263
72 36	5		TAS-10-7236	110	TAS-15-7236	123	TAS-20-7236	123
72 48	7		TAS-10-7248	157	TAS-15-7248	191	TAS-20-7248	191
72 60	10		TAS-10-7260	223	TAS-15-7260	238	TAS-20-7260	253

Dockboard Accessories for series BTA & TAS

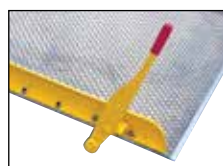

LEVERLIFT
model ALL



LIFTING CHAINS
series LC



SLIDING SPAN LOCKS
model SSL



Video
Available



POWDER
COATED
TOUGH

ALUMINUM DOCKBOARD OPTIONS • series BTA & TAS			
MODEL NUMBER	DESCRIPTION	MODEL NUMBER	DESCRIPTION
LC48-66	Lifting Chains 48"W - 66"W	HOLE	Extra Span Holes
LC72-84	Lifting Chains 72"W - 84"W	PIN	Extra Span Pins
SSL	Sliding Span Locks (BTA only)	ALL	Leverlift
HDL	Dockboard Handle Kit	SB	Second Bend
SP	Span Pins & Holes (4 holes per side)	ATC-12	Anti-Theft Chain (144")
RPL	Removable Pickup Loop		

AHTD OPTIONS
CAN BE FOUND
ON PAGE A17

Aluminum Hand Truck Dockboards

The Aluminum Hand Truck Dockboards are lightweight and can be carried and positioned by one person. Provides a safe and convenient bridge between dock and truck. Welded aluminum diamond tread plate surface and beveled edges provide safe and smooth entry and exit. The bend is designed to keep ramp edges flush with the dock surface and the truck floor. The unit is equipped with bolt-on locking legs and full length aluminum curbs that provide hand holds and reduce chance of roll off. 800 pound uniform capacity. Designed for use with two-wheeled hand trucks. 3/16" plate thickness. Manufactured in compliance with OSHA.

MODEL NUMBER	OVERALL WIDTH	USABLE WIDTH	OVERALL LENGTH	HEIGHT DIFFERENTIAL	WEIGHT (POUNDS)
AHTD-3036	31¼"	28"	35 ⁷ / ₈ "	5½"	35
AHTD-3048	31¼"	28"	47 ⁷ / ₈ "	8½"	46
AHTD-3648	37¼"	34"	47 ⁷ / ₈ "	8½"	51
AHTD-3660	37¼"	34"	59 ⁷ / ₈ "	11½"	65
AHTD-3672	37¼"	34"	71 ⁷ / ₈ "	14½"	75
AHTD-3696	37¼"	34"	95 ⁷ / ₈ "	17½"	107

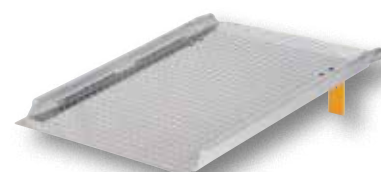

Video
Available

48 Hours
to Ship

DESIGNED FOR USE
WITH TWO WHEEL
HAND TRUCKS
(not included)

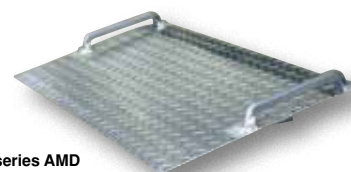
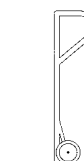

series AMD



Video
Available

48 Hours
to Ship



Aluminum Mini Dockplates

The Aluminum Mini Dockplate can scale 3" to 5" high curbs and door thresholds. Ideal for use with two-wheeled hand truck for deliveries. Aluminum construction is lightweight yet durable, 1/8" thick plate. Features carrying handles and diamond tread plate surface for better traction.

MODEL NUMBER	OVERALL WIDTH	USABLE WIDTH	OVERALL LENGTH	MAXIMUM SINGLE AXL CAPACITY	UNIFORM CAPACITY	WEIGHT (POUND)
AMD-2418	24"	21½"	18"	400 lbs.	500 lbs.	9
AMD-3018	30"	27½"	18"	400 lbs.	600 lbs.	10
AMD-3618	36"	33½"	18"	400 lbs.	700 lbs.	11

Steel Truck Dockboards



The Steel Truck Dockboard is constructed of high strength (55,000 psi) steel for long life. Beveled edges on both ends permit smooth entry and exit. Deck is diamond plated for safe, efficient use. Welded safety curbs for maximum strength. Locking legs minimize ramp movement and are uneven to allow the dockboard to sit canted for easier floor pickup by fork trucks when not in use. Legs are located 12" from the edge of the dockboard. The bend is 11 degrees and 9 inches from beveled edge. Standard with Lever Lift for quick portability with fork truck. Manufactured in compliance with OSHA. Optional accessories: lifting chains, span locks, span pins/holes, and removable pickup loops.

UNIFORM CAPACITY		10,000 LBS.		15,000 LBS.		20,000 LBS.	
Size (Inches) Width x Length	Ht. Difference 11° / 19% Inches	MODEL NUMBER	WEIGHT (POUND)	MODEL NUMBER	WEIGHT (POUND)	MODEL NUMBER	WEIGHT (POUND)
60 36	5	TS-10-6036	259	TS-15-6036	295	TS-20-6036	303
60 48	7	TS-10-6048	388	TS-15-6048	390	TS-20-6048	433
60 60	10	TS-10-6060	447	TS-15-6060	458	TS-20-6060	582
60 72	12	TS-10-6072	535	TS-15-6072	601	TS-20-6072	791
66 36	5	TS-10-6636	318	TS-15-6636	353	TS-20-6636	359
66 48	7	TS-10-6648	424	TS-15-6648	461	TS-20-6648	421
66 72	12	TS-10-6672	647	TS-15-6672	686	TS-20-6672	768
72 36	5	TS-10-7236	300	TS-15-7236	347	TS-20-7236	390
72 48	7	TS-10-7248	386	TS-15-7248	386	TS-20-7248	512
72 54	8-1/2	TS-10-7254	556	TS-15-7254	505	TS-20-7254	641
72 60	10	TS-10-7260	563	TS-15-7260	552	TS-20-7260	647
72 72	12	TS-10-7272	721	TS-15-7272	668	TS-20-7272	919
84 36	5	TS-10-8436	346	TS-15-8436	393	TS-20-8436	449
84 48	7	TS-10-8448	567	TS-15-8448	507	TS-20-8448	548
84 60	10	TS-10-8460	671	TS-15-8460	648	TS-20-8460	730
Size (Inches) Width x Length	Ht. Difference 11° / 19% (In)	25,000 LBS.		30,000 LBS.		STEEL DOCKBOARD OPTIONS	
60 36	5	TS-25-6036	447	TS-30-6036	467	LC48-66-STL	Lifting Chains 48"-66"
60 48	7	TS-25-6048	562	TS-30-6048	485	LC72-84-STL	Lifting Chains 72"-84"
60 60	10	TS-25-6060	695	TS-30-6060	738	RPL-STL	Removable Pickup Loops
60 72	12	TS-25-6072	791	TS-30-6072	952	SSL-STL	Sliding Span Locks
66 36	5	TS-25-6636	483	TS-30-6636	554	SP-STL	Span Pins & Holes (4)
66 48	7	TS-25-6648	516	TS-30-6648	730	HOLE-STL	Extra Span Holes
66 72	12	TS-25-6672	855	TS-30-6672	1032	PIN-STL	Extra Span Pins
72 36	5	TS-25-7236	437	TS-30-7236	507	HDL-STL	Handle Kit
72 48	7	TS-25-7248	547	TS-30-7248	688	SB-STL	Second Bend
72 54	8-1/2	TS-25-7254	628	TS-30-7254	750	ATC-12	Anti-Theft Chain (144")
72 60	10	TS-25-7260	807	TS-30-7260	833		
72 72	12	TS-25-7272	859	TS-30-7272	1111		
84 36	5	TS-25-8436	563	TS-30-8436	681		
84 48	7	TS-25-8448	741	TS-30-8448	858		
84 60	10	TS-25-8460	878	TS-30-8460	1007		



Call us for special sizes and configurations.



Steel Truck Dockplates

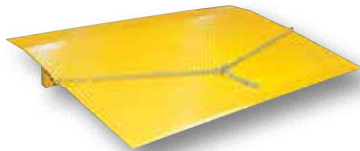

The Steel Truck Dockplate is constructed of high strength INX-55 (55,000 psi) steel. Safety locking legs prevent slippage between truck and dock. Safety tread plate helps provide positive traction. Beveled edges for smooth entry and exit. Chain pickup comes standard. Designed with an 11° bend located 9" from the beveled edge. The legs are 10" from the beveled edge. Manufactured in compliance with OSHA. When using three-wheeled pallet trucks, select capacity +20% due to concentrated load center of board.

OVERALL WIDTH	OVERALL LENGTH	HEIGHT DIFF.	3/8" PLATE THICKNESS			1/2" PLATE THICKNESS					
			MODEL NUMBER	UNIFORM CAPACITY	NET WT. (POUND)	MODEL NUMBER	UNIFORM CAPACITY	NET WT. (POUND)			
48"	30"	4"	SE-4830	5,000 lb.	177	SEH-4830	8,800 lb.	227			
48"	36"	5"	SE-4836	4,125 lb.	215	SEH-4836	7,300 lb.	263			
48"	48"	7"	SE-4848	3,090 lb.	324	SEH-4848	5,500 lb.	429			
48"	60"	9"	SE-4860	2,475 lb.	341	SEH-4860	4,400 lb.	528			
54"	30"	4"	SE-5430	5,500 lb.	235	SEH-5430	9,900 lb.	253			
54"	36"	5"	SE-5436	4,600 lb.	277	SEH-5436	8,250 lb.	371			
54"	48"	7"	SE-5448	3,450 lb.	304	SEH-5448	6,185 lb.	486			
54"	60"	9"	SE-5460	2,760 lb.	444	SEH-5460	4,950 lb.	575			
60"	36"	5"	SE-6036	5,150 lb.	261	SEH-6036	9,160 lb.	317			
60"	48"	7"	SE-6048	3,860 lb.	362	SEH-6048	6,875 lb.	445			
60"	60"	9"	SE-6060	3,090 lb.	498	SEH-6060	5,500 lb.	554			
72"	60"	9"	SE-7260	3,860 lb.	475	SEH-7260	6,600 lb.	627			
STEEL DOCKPLATE OPTIONS • series SE & SEH											
LC48-66-STL			Lifting Chains 48"-66"			SP-STL			Span Pins & Holes (4)		
LC72-84-STL			Lifting Chains 72"-84"			HOLE-STL			Extra Span Holes		
RPL-STL			Removable PU Loops			PIN-STL			Extra Span Pins		
						ATC-12			Anti-Theft Chain (144")		



Aluminum Wheel Risers

Elevate semi-trailers to loading docks for maximum serviceability during loading and unloading operations. Manufactured from heavy-duty aluminum tread plate for positive traction. All welded aluminum construction. 30,000 lb. uniform capacity per pair (sold each). Wheel Risers are designed to raise the trailer for loading and unloading to facilitate compliance with OSHA/ANSI B56.1 part 3 sec 7 requirements for maximum grade of ascending or descending loaded fork trucks.

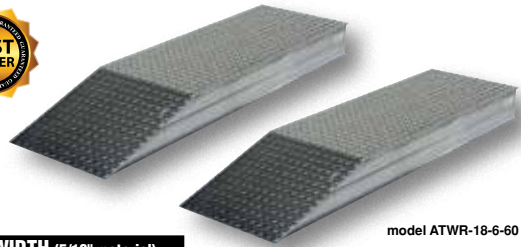

model ATWR-18-6-60

HEIGHT	OVERALL LENGTH	LEVEL LENGTH	18" USABLE WIDTH (1/4" material)		24" USABLE WIDTH (5/16" material)	
			MODEL NUMBER	WEIGHT (EACH)	MODEL NUMBER	WEIGHT (EACH)
6"	48"	30"	ATWR-18-6-48	41	ATWR-24-6-48	59
	54"	36"	ATWR-18-6-54	46	ATWR-24-6-54	60
	60"	42"	ATWR-18-6-60	87	ATWR-24-6-60	110
	102"	84"	ATWR-18-6-102	122	ATWR-24-6-102	162
8"	54"	30"	ATWR-18-8-54	56	ATWR-24-8-54	112
	60"	36"	ATWR-18-8-60	98	ATWR-24-8-60	122
	66"	42"	ATWR-18-8-66	109	ATWR-24-8-66	135
10"	108"	84"	ATWR-18-8-108	148	ATWR-24-8-108	194
	60"	30"	ATWR-18-10-60	108	ATWR-24-10-60	133
	66"	36"	ATWR-18-10-66	111	ATWR-24-10-66	142
	72"	42"	ATWR-18-10-72	121	ATWR-24-10-72	156
12"	114"	84"	ATWR-18-10-114	175	ATWR-24-10-114	229
	66"	30"	ATWR-18-12-66	125	ATWR-24-12-66	160
	72"	36"	ATWR-18-12-72	131	ATWR-24-12-72	169
	78"	42"	ATWR-18-12-78	144	ATWR-24-12-78	191
12"	120"	84"	ATWR-18-12-120	208	ATWR-24-12-120	270



PORTABILITY KIT, model ATWR-WL, allows one person to transport and place wheel riser. Features 5" x 2" mold-on-rubber wheels. For use with aluminum wheel risers only.

ADD A WHEEL TO A SINGLE ALUMINUM WHEEL RISER FOR PORTABILITY. MODEL ATWR-WL
 OPTIONAL WELDED FORK POCKETS, 7 1/2"W x 2 1/2"H, MODEL ATWR-FP
 PORTABLE WHEEL RISER CADDY, MODEL R-CAD-18, for 18" wide units, (1) Caddy, (1) pair of brackets
 PORTABLE WHEEL RISER CADDY, MODEL R-CAD-24, for 24" wide units, (1) Caddy, (1) pair of brackets
 ONE PAIR OF BOLT-ON BRACKETS AND HARDWARE, MODEL R-CAD-KIT
 ANCHOR BRACKETS (4 PER RISER) TO BOLT RISER TO GROUND, MODEL ATWR-ABRK

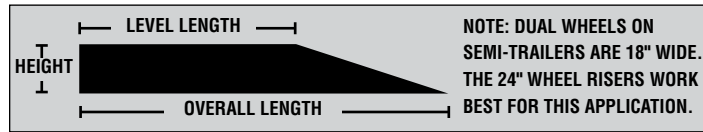

FORK POCKETS ARE STANDARD FOR EASY TRANSPORTATION

Steel Wheel Risers

WHEEL RISERS ARE PRICED AND SOLD EACH

The Steel Wheel Riser is equipped with fork slots for ease in fork truck transporting. Ramps may be stacked for compact storage when not in use. Fork pockets are 7 1/2" wide by 2 1/2" high usable. These fork pockets add approximately 15" to the overall width of the riser. Wheel Risers are designed to raise the trailer for loading and unloading to facilitate compliance with OSHA/ANSI B56.1 part 3 sec 7 requirements for maximum grade of ascending or descending loaded fork trucks. Made of heavy-duty welded steel construction. Uniform capacity per pair is 40,000 lb. (1/4" thick material) (sold each). Units over 168" long are built and ship in two (2) pieces.

HEIGHT	OVERALL LENGTH	LEVEL LENGTH	18" USABLE WIDTH		24" USABLE WIDTH	
			MODEL NUMBER	WEIGHT (EACH)	MODEL NUMBER	WEIGHT (EACH)
6 1/4"	48"	24"	SWR-18-6-48	233	SWR-24-6-48	218
	60"	36"	SWR-18-6-60	255	SWR-24-6-60	266
	72"	48"	SWR-18-6-72	296	SWR-24-6-72	310
	84"	60"	SWR-18-6-84	353	SWR-24-6-84	363
8 1/4"	60"	28"	SWR-18-8-60	324	SWR-24-8-60	271
	72"	40"	SWR-18-8-72	347	SWR-24-8-72	334
	84"	52"	SWR-18-8-84	388	SWR-24-8-84	398
10 1/4"	96"	64"	SWR-18-8-96	445	SWR-24-8-96	416
	60"	20"	SWR-18-10-60	237	SWR-24-10-60	330
	72"	32"	SWR-18-10-72	300	SWR-24-10-72	361
	84"	44"	SWR-18-10-84	346	SWR-24-10-84	448
12 1/4"	96"	56"	SWR-18-10-96	392	SWR-24-10-96	486
	72"	24"	SWR-18-12-72	360	SWR-24-12-72	428
	84"	36"	SWR-18-12-84	425	SWR-24-12-84	499
	96"	48"	SWR-18-12-96	450	SWR-24-12-96	537
12 1/4"	108"	60"	SWR-18-12-108	503	SWR-24-12-108	581

PORTABLE WHEEL RISER CADDY, MODEL R-CAD-18, for 18" wide units, (1) Caddy, (1) pair of brackets
 PORTABLE WHEEL RISER CADDY, MODEL R-CAD-24, for 24" wide units, (1) Caddy, (1) pair of brackets
 ONE PAIR OF WELD-ON BRACKETS AND HARDWARE, MODEL R-CAD-KIT (FACTORY INSTALLED)
 ANCHOR BRACKETS (4 PER RISER) TO BOLT RISER TO GROUND, MODEL SWR-ABRK, (FACTORY INSTALLED)
 CENTRAL PICKUP LOOP, MODEL SWR-CPL, (FACTORY INSTALLED), ADDITIONAL WEIGHT 186 LBS.

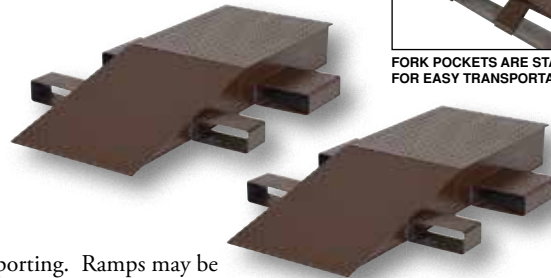

model R-CAD-KIT



PORTABLE WHEEL RISER CADDY, series R-CAD, move steel or aluminum risers out of the way with this easy to use mover. Snap roller into riser and away you go.



CENTRAL PICK-UP LOOP, model SWR-CPL, is used to connect two wheel risers (factory installed). Allows fork trucks to easily position and move risers as one. Overall width is 102".

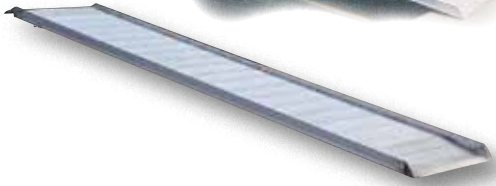

Aluminum Walk Ramps

The Aluminum Walk Ramp enables delivery personnel, shippers, and receivers to load and unload trucks when docks are unavailable. Ramps feature a 1½" high safety curb on each side. Heavy-duty steel chains with steel grab hooks are attached to each side of ramp for safely securing ramp to truck. Constructed of strong aluminum alloy with non-skid tread surface. The ramp is lightweight and easy to handle. Available in either an overlapping style that rests on the truck bed, suffix "A", or steel hook style that mounts onto the truck extensions, suffix "B".



TYPE A - OVERLAP



TYPE B - STEEL HOOKS



DECK CROSS-SECTION

TYPE	HEIGHT RANGE	LENGTH	UNIFORM CAPACITY		28" WIDE / 26" USABLE		38" WIDE / 36" USABLE	
			4-WHEEL CART	2-WHEEL CART	MODEL NUMBER	WEIGHT (POUND)	MODEL NUMBER	WEIGHT (POUND)
A	6" - 21"	6'	2,800 lb.	2,000 lb.	AWR-28-6A	68	AWR-38-6A	86
A	6" - 25"	7'	2,800 lb.	1,800 lb.	AWR-28-7A	78	AWR-38-7A	88
A	6" - 29"	8'	2,500 lb.	1,650 lb.	AWR-28-8A	84	AWR-38-8A	105
A	6" - 33"	9'	2,500 lb.	1,600 lb.	AWR-28-9A	95	AWR-38-9A	113
A	6" - 38"	10'	2,200 lb.	1,500 lb.	AWR-28-10A	101	AWR-38-10A	125
A	6" - 46"	12'	1,900 lb.	1,400 lb.	AWR-28-12A	128	AWR-38-12A	150
A	6" - 54"	14'	1,600 lb.	1,200 lb.	AWR-28-14A	136	AWR-38-14A	168
A	6" - 62"	16'	1,000 lb.	1,000 lb.	AWR-28-16A	153	AWR-38-16A	198
B	6" - 23"	6'	2,800 lb.	2,000 lb.	AWR-28-6B	68	AWR-38-6B	88
B	6" - 27"	7'	2,800 lb.	1,800 lb.	AWR-28-7B	78	AWR-38-7B	88
B	6" - 31"	8'	2,500 lb.	1,650 lb.	AWR-28-8B	84	AWR-38-8B	105
B	6" - 35"	9'	2,500 lb.	1,600 lb.	AWR-28-9B	95	AWR-38-9B	113
B	6" - 40"	10'	2,200 lb.	1,500 lb.	AWR-28-10B	105	AWR-38-10B	125
B	6" - 48"	12'	1,900 lb.	1,400 lb.	AWR-28-12B	128	AWR-38-12B	150
B	6" - 56"	14'	1,600 lb.	1,200 lb.	AWR-28-14B	136	AWR-38-14B	168
B	6" - 64"	16'	1,000 lb.	1,000 lb.	AWR-28-16B	154	AWR-38-16B	190



model
AWR-28-8A-HR

Aluminum Walk Ramps with Aluminum Handrail

Aluminum Walk Ramps with Handrail offer the same durable ramp as above with more stability and security. Railing sections are 42" high with a 21" mid-rail. Handrail can be bolted onto both A-style and B-style aluminum walk ramps. Handrail may be attached to one side or both sides of ramp. Aluminum construction with unpainted finish. Installation brackets and hardware included. Retrofit railing available for existing aluminum walk ramps.

RETROFIT HANDRAIL FOR EXISTING ALUMINUM WALK RAMPS					
MODEL	LENGTH	WEIGHT	MODEL	LENGTH	WEIGHT
AWR-HR-6-RF	6'	24	AWR-HR-10-RF	10'	36
AWR-HR-7-RF	7'	26	AWR-HR-12-RF	12'	52
AWR-HR-8-RF	8'	30	AWR-HR-14-RF	14'	60
AWR-HR-9-RF	9'	32	AWR-HR-16-RF	16'	64

TYPE	HEIGHT RANGE	LENGTH	UNIFORM CAPACITY		28" WIDE / 26" USABLE		38" WIDE / 36" USABLE	
			4-WHEEL CART	2-WHEEL CART	MODEL NUMBER	WEIGHT (POUND)	MODEL NUMBER	WEIGHT (POUND)
A	6" - 21"	6'	2,800 lb.	2,000 lb.	AWR-28-6A-HR	68	AWR-38-6A-HR	86
A	6" - 25"	7'	2,800 lb.	1,800 lb.	AWR-28-7A-HR	78	AWR-38-7A-HR	88
A	6" - 29"	8'	2,500 lb.	1,650 lb.	AWR-28-8A-HR	84	AWR-38-8A-HR	105
A	6" - 33"	9'	2,500 lb.	1,600 lb.	AWR-28-9A-HR	95	AWR-38-9A-HR	113
A	6" - 38"	10'	2,200 lb.	1,500 lb.	AWR-28-10A-HR	101	AWR-38-10A-HR	125
A	6" - 46"	12'	1,900 lb.	1,400 lb.	AWR-28-12A-HR	128	AWR-38-12A-HR	150
A	6" - 54"	14'	1,600 lb.	1,200 lb.	AWR-28-14A-HR	136	AWR-38-14A-HR	168
A	6" - 62"	16'	1,000 lb.	1,000 lb.	AWR-28-16A-HR	153	AWR-38-16A-HR	198
B	6" - 23"	6'	2,800 lb.	2,000 lb.	AWR-28-6B-HR	68	AWR-38-6B-HR	88
B	6" - 27"	7'	2,800 lb.	1,800 lb.	AWR-28-7B-HR	78	AWR-38-7B-HR	88
B	6" - 31"	8'	2,500 lb.	1,650 lb.	AWR-28-8B-HR	84	AWR-38-8B-HR	105
B	6" - 35"	9'	2,500 lb.	1,600 lb.	AWR-28-9B-HR	95	AWR-38-9B-HR	113
B	6" - 40"	10'	2,200 lb.	1,500 lb.	AWR-28-10B-HR	105	AWR-38-10B-HR	125
B	6" - 48"	12'	1,900 lb.	1,400 lb.	AWR-28-12B-HR	128	AWR-38-12B-HR	150
B	6" - 56"	14'	1,600 lb.	1,200 lb.	AWR-28-14B-HR	136	AWR-38-14B-HR	168
B	6" - 64"	16'	1,000 lb.	1,000 lb.	AWR-28-16B-HR	154	AWR-38-16B-HR	190

Aluminum Grip-Strut Walk Ramps

Load and unload trucks when docks are unavailable. The open deck design allows snow, ice, and water to fall through ramp providing a positive grip for delivery personnel, shippers, and receivers. One hundred percent welded aluminum construction is lightweight and will not rust. Ramps feature a 2" high safety curb on each side. Overlap style end lip rests on the trailer bed to provide a smooth transition. Each unit includes two (2) safety chains to connect the ramp to the trailer for safety. Not for pallet trucks or three-wheeled carts.

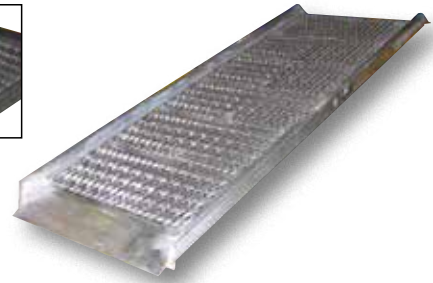

HEIGHT RANGE	LENGTH	UNIFORM CAPACITY		29-3/8" WIDE / 26" USABLE		39-3/8" WIDE / 36" USABLE	
		4-WHEEL CART	2-WHEEL CART	MODEL NUMBER	WEIGHT (POUND)	MODEL NUMBER	WEIGHT (POUND)
6" - 21"	6'	2,800 lb.	2,000 lb.	AWR-G-28-6A	41	AWR-G-38-6A	55
6" - 25"	7'	2,800 lb.	1,800 lb.	AWR-G-28-7A	59	AWR-G-38-7A	59
6" - 29"	8'	2,500 lb.	1,650 lb.	AWR-G-28-8A	61	AWR-G-38-8A	66
6" - 33"	9'	2,500 lb.	1,600 lb.	AWR-G-28-9A	63	AWR-G-38-9A	73
6" - 38"	10'	2,200 lb.	1,500 lb.	AWR-G-28-10A	68	AWR-G-38-10A	80
6" - 46"	12'	1,900 lb.	1,400 lb.	AWR-G-28-12A	77	AWR-G-38-12A	94
6" - 56"	14'	1,600 lb.	1,200 lb.	AWR-G-28-14A	89	AWR-G-38-14A	123
6" - 62"	16'	1,000 lb.	1,000 lb.	AWR-G-28-16A	122	AWR-G-38-16A	142
ALUMINUM GRIP-STRUT WALK RAMP WITH HANDRAIL							
6" - 21"	6'	2,800 lb.	2,000 lb.	AWR-G-28-6A-HR	41	AWR-G-38-6A-HR	55
6" - 25"	7'	2,800 lb.	1,800 lb.	AWR-G-28-7A-HR	59	AWR-G-38-7A-HR	59
6" - 29"	8'	2,500 lb.	1,650 lb.	AWR-G-28-8A-HR	61	AWR-G-38-8A-HR	66
6" - 33"	9'	2,500 lb.	1,600 lb.	AWR-G-28-9A-HR	63	AWR-G-38-9A-HR	73
6" - 38"	10'	2,200 lb.	1,500 lb.	AWR-G-28-10A-HR	68	AWR-G-38-10A-HR	80
6" - 46"	12'	1,900 lb.	1,400 lb.	AWR-G-28-12A-HR	77	AWR-G-38-12A-HR	94
6" - 56"	14'	1,600 lb.	1,200 lb.	AWR-G-28-14A-HR	89	AWR-G-38-14A-HR	123
6" - 62"	16'	1,000 lb.	1,000 lb.	AWR-G-28-16A-HR	122	AWR-G-38-16A-HR	142

Aluminum Walk Ramp Options

Ramp Cart Option, provides for easy one-person ramp positioning and transporting. Pull handle up to vertical position to rotate and lock wheels in down position. Push handle down to unlock and lift wheels so ramp can be used to service lower trailers. Hard rubber wheels measure 10" x 2½". Minimum ramp service height is 14" with this option. Easy bolt-on installation. Walk ramp sold separately.

Adjustable Height Wheel Option, is ideal for use with aluminum ramps 8 feet or longer. Height is adjusted with a manual hand crank mechanism. Wheels are 10" x 3½" pneumatic and are located at balance points on the ramp. Simple bolt-on installation. Minimum ramp lowered height with this option is 12". Walk ramp sold separately.

MODEL NUMBER	STYLE	WEIGHT (POUND)
AWR-R-CART-28	RAMP CART OPTION	55
AWR-R-CART-38	RAMP CART OPTION	65
AWR-WHL-28	ADJUSTABLE HEIGHT WHEEL OPTION, 28"W UNITS	135
AWR-WHL-38	ADJUSTABLE HEIGHT WHEEL OPTION, 38"W UNITS	137



Aluminum Truck Mounted Walk Ramps

Ramp includes steel pocket frame for under-truck mounting. Frame includes linkage to prevent ramp from falling out. Manual spring-loaded lock secures ramp into frame. Handle loops are included to help with deploying the ramp. Overlap style end lip rests on trailer bed and provides smooth transition. Each unit includes two (2) safety chains to connect ramp to trailer for safety. Curb height is 2". Solid treadplate deck type features non-slip serrations for extra grip. 100% welded aluminum construction is light-weight and will not rust.

HEIGHT RANGE	USABLE LENGTH	UNIFORM CAPACITY (LBS.)		TREADPLATE 28" WIDE / 26" USABLE	
		4-WHEEL CART	2-WHEEL CART	MODEL NUMBER	WEIGHT (POUND)
6" - 46"	144 ⁷ / ₁₆ "	1,900	1,400	AWR-TM-28-12A	203
6" - 54"	170 ⁵ / ₁₆ "	1,600	1,200	AWR-TM-28-14A	231
6" - 62"	189"	1,000	1,000	AWR-TM-28-16A	255





Heavy-Duty Fiberglass Walk Ramps

Load and unload equipment from trucks using these Heavy-Duty Fiberglass Walk Ramps. Reinforced fiberglass construction provides up to 3,000 pounds capacity. Abrasive surface provides good traction in wet or dry conditions. 1" high curb on each side of ramp. Not for use with fork trucks or pallet trucks.



ROUGH TEXTURE

MODEL NUMBER	OVERALL WIDTH	OVERALL LENGTH	UNIFORM CAPACITY	MAXIMUM WORKING HEIGHT	WEIGHT (POUND)
FWR-3010-50	30"	10'	3,000 lb.	30"	1030
FWR-3012-50	30"	12'	3,000 lb.	35"	1230
FWR-3014-50	30"	14'	3,000 lb.	45"	1430
FWR-3610-50	36"	10'	3,000 lb.	30"	1036
FWR-3612-50	36"	12'	3,000 lb.	35"	1236
FWR-3614-50	36"	14'	3,000 lb.	45"	1436



Fiberglass Autoloader Ramps

The Autoloader Ramp can be separated in half to provide two ramps that may be used to load automobiles and other vehicles. Each half is 18" wide and handles 2,500 pounds. To separate simply remove center hinge pins.

MODEL NUMBER	OVERALL WIDTH	OVERALL LENGTH	UNIFORM CAPACITY	MAXIMUM WORKING HEIGHT	WEIGHT (POUND)
FAL-3610-50	36"	10'	5,000 lb.	30"	255
FAL-3612-50	36"	12'	5,000 lb.	35"	290
FAL-3614-50	36"	14'	5,000 lb.	45"	330
FAL-3616-50	36"	16'	5,000 lb.	50"	385



Aluminum Vehicle Twin Ramps

Provide a safe means for driving vans, pick-up trucks, and some passenger vehicles from ground level into and out of high building entrances. Ramps can be securely fastened to dock with (2) 3/4" chains each with hook on the end. To avoid hang-ups, measure under clearance and wheelbase of vehicle. The usable width is 14". Side curbs are 1/4" high. Welded aluminum construction. Sold in pairs.

MODEL NUMBER	OVERALL WIDTH	OVERALL LENGTH	UNIFORM CAPACITY	MAX to MIN WORKING HEIGHT	WEIGHT (POUND)
VTR-7-14-8	17 ⁵ / ₁₆ "	8'	7,000 lb.	17 ¹ / ₂ " to 12 ¹ / ₂ "	275
VTR-5.5-14-10	17 ⁵ / ₁₆ "	10'	5,500 lb.	22 ¹ / ₂ " to 16"	284
VTR-7-14-12	17 ⁵ / ₁₆ "	12'	7,000 lb.	27" to 19"	417
VTR-6-14-14	17 ⁵ / ₁₆ "	14'	6,000 lb.	32" to 22 ¹ / ₂ "	487
VTR-5.5-14-16	17 ⁵ / ₁₆ "	16'	5,500 lb.	36 ¹ / ₂ " to 25 ¹ / ₂ "	586
VTR-6-14-18	18 ⁹ / ₁₆ "	18'	6,000 lb.	41" to 29"	586
VTR-5.5-14-20	18 ⁹ / ₁₆ "	20'	5,500 lb.	46" to 32 ¹ / ₂ "	837
VTR-5.5-14-24	18 ⁹ / ₁₆ "	24'	5,500 lb.	55 ¹ / ₂ " to 39"	1031

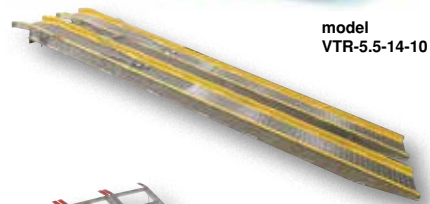

model VTR-5.5-14-10

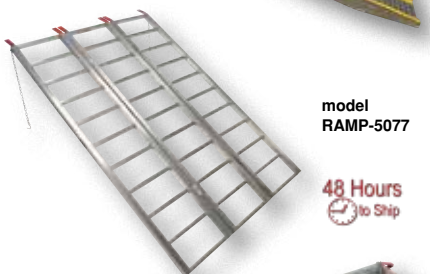

model RAMP-5077

48 Hours to Ship

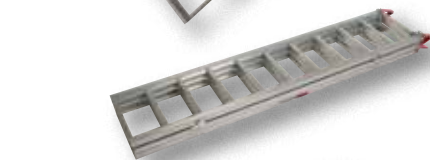

Aluminum Pick-Up/Van Ramp

Lightweight aluminum ramp works great for large and small wheeled equipment. When using with small wheeled equipment add 1/4" plywood (not included) to ramp surface. Folds up to 16 1/2" wide for storing between ATV wheels in truck. Includes adjustable safety straps to hook ramp safely to trailer. Height unfolded is 1 1/2". Folded height is 5 1/2".

MODEL NUMBER	LENGTH	UNFOLDED WIDTH	GROSS UNIFORM CAPACITY	SINGLE WHEEL UNIFORM CAPACITY	WEIGHT (POUND)
RAMP-5077	78"	50"	1,500 lbs.	250 lb.	37



model RAMP-SF

Folding Ramp

Meet ADA requirements with these handy lightweight compact ramps. Assembly required. Single fold ramp measures 14-3/16"W x 72"L x 3 1/2"H when folded. It has a 1/4" curb and 2 1/2" lip. The ramp is serrated and has debris slots.

MODEL NUMBER	UNFOLDED (W x L x H)	FOLDED (W x L x H)	UNIFORM CAPACITY	WEIGHT (POUND)
RAMP-SF	28 ⁵ / ₁₆ " x 72" x 2 ⁹ / ₁₆ "	14 ³ / ₁₆ " x 72" x 3 ¹ / ₂ "	500 lb.	37

Steel Pick-Up/Van Ramps

These economical serrated ramps provide minimum slippage. Overlapping lip provides smooth transition into cargo area. Single piece construction with bolt-on lip.

MODEL NUMBER	LENGTH	WIDTH PER RAMP	GROSS UNIFORM CAPACITY	SINGLE WHEEL UNIFORM CAPACITY	WEIGHT (POUND)
RAMP-72 [Ⓢ]	72"	9"	1,000 lb.	500 lb.	43 pr.
RAMP-96 [Ⓢ]	96"	9"	1,000 lb.	500 lb.	60 pr.

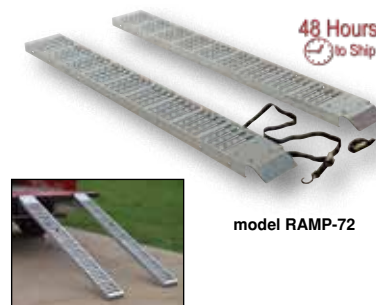

model RAMP-72

Wooden Ramp Kits

Kits allow for building wooden ramps using common lumber. Each kit includes two (2) steel end plates and rubber bottom tips. Installation hardware is included. Drilling required for installation. Lumber/boards are not included.

MODEL NUMBER	DESCRIPTION	USABLE LUMBER SIZE	WEIGHT (POUND)
RK-8 [Ⓢ]	WOODEN RAMP KIT	8" x 2"	10
RK-12 [Ⓢ]	WOODEN RAMP KIT	12" x 2"	16

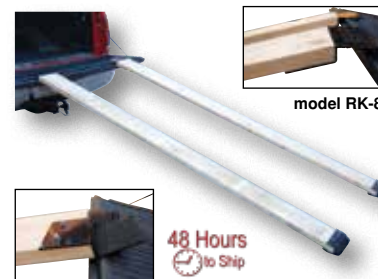

model RK-8

Steel Container Ramps

Heavy duty steel container ramp facilitates easy loading/unloading of shipping containers when placed on ground level. Hinged flip-over bridge allows for easy transportation and compact storage. Tapered lip provides smooth transition into container at various heights. Built-in fork pockets in base for convenient fork truck positioning.

MODEL NUMBER	OVERALL WIDTH	OVERALL LENGTH	HEIGHT	UNIFORM CAPACITY	WEIGHT (POUND)
SCR-72	76½"	98⅞"	4⅝"	15,000 lb.	816
SCR-84	88½"	98⅞"	4⅝"	15,000 lb.	924



Wheel Chair Ramps

The Americans with Disabilities Act requires that all buildings must be accessible to disabled persons. Failure to comply may result in monetary damages and civil penalties. According to ADA rules and regulations, for every inch of rise you must have a foot of ramp in length.



A) TELESCOPIC RAMP is constructed of lightweight aluminum extrusion. Top surface is serrated for positive traction.

B) FOLD-A-WAY RAMP easy, one person storage and handling. Slip-resistant surface provides extra traction. Each ramp comes with 2 handles for easy positioning.



C) GRATE RAMP is a semi-permanent ramp that is ideal for high traffic areas. Handrails are available.



D) ROLL-O-RAMP provides access over curbs. Wheels installed on curb of ramp for portability. Beveled edges create smooth transition between ramp and ground.

TYPE	MODEL NUMBER	DIMENSIONS (WIDTH x LENGTH)	UNIFORM CAPACITY	WEIGHT (POUND)
A	D-TR-72	9⅞" x 72"	550 lb.	38
A	D-TR-88	9⅞" x 88"	550 lb.	44 pr.
B	D-FAR-120	12⅞" x 124"	550 lb.	78 pr.
C	D-AW-88	36" x 88"	500 lb.	182
C	D-AW-132	36" x 132"	500 lb.	177
C	D-AW-168	36" x 168"	500 lb.	227
D	D-ROL-48	36⅝" x 48"	500 lb.	52

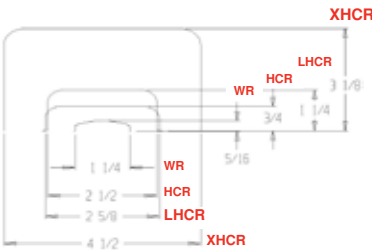
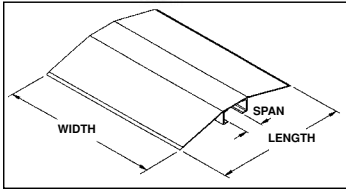
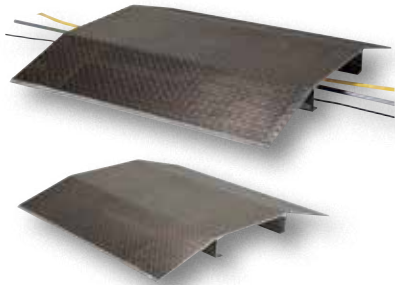

Fabricated Aluminum Hose & Cable Crossovers

Protect hoses and cables from carts and other traffic. Constructed of lightweight durable welded aluminum tread plate. All welded. The opening is available in spans of 4" to 16". (3/8" thick plate).

MODEL NUMBER	OVERALL SIZE (W x L)	USABLE SPAN (W x H)	UNIFORM CAPACITY	WEIGHT (POUND)
FHCR-24-36-4	24" x 36"	4" x 3"	2,000 lb.	33
FHCR-24-40-8	24" x 40"	8" x 3"	2,000 lb.	38
FHCR-24-44-12	24" x 44"	12" x 3"	2,000 lb.	39
FHCR-24-48-16	24" x 48"	16" x 3"	2,000 lb.	44
FHCR-24-36-4-4H	24" x 36"	4" x 4"	2,000 lb.	83
FHCR-24-40-8-4H	24" x 40"	8" x 4"	2,000 lb.	85
FHCR-24-44-12-4H	24" x 44"	12" x 4"	2,000 lb.	43
FHCR-24-48-16-4H	24" x 48"	16" x 4"	2,000 lb.	90
FHCR-48-36-4	48" x 36"	4" x 3"	2,000 lb.	60
FHCR-48-40-8	48" x 40"	8" x 3"	2,000 lb.	115
FHCR-48-44-12	48" x 44"	12" x 3"	2,000 lb.	132
FHCR-48-48-16	48" x 48"	16" x 3"	2,000 lb.	128
FHCR-48-36-4-4H	48" x 36"	4" x 4"	2,000 lb.	121
FHCR-48-40-8-4H	48" x 40"	8" x 4"	2,000 lb.	137
FHCR-48-44-12-4H	48" x 44"	12" x 4"	2,000 lb.	129
FHCR-48-48-16-4H	48" x 48"	16" x 4"	2,000 lb.	133

Extruded Aluminum Hose & Cable Crossovers

Designed to protect cables and hoses from pedestrian and rolling traffic. Heavy duty aluminum construction is durable and attractive. Top surface of each crossover includes serrations for better traction. Color finish is baked-in powder-coated for toughness. Contact factory for special lengths up to 25 feet.

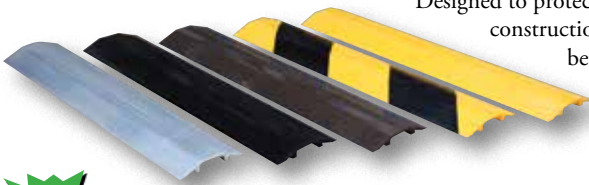

OVERALL (W x H)	USABLE SPAN (W x H)	OVERALL LENGTH	SINGLE WHEEL CAPACITY	WEIGHT (POUND)	ALUMINUM	BLACK	BROWN
					MODEL NUMBER	MODEL NUMBER	MODEL NUMBER
27/8" x 7/16"	1 1/4" x 5/16"	24"	2,500 lb.	2	WR-24	WR-24-BK	WR-24-BRN
		36"	2,500 lb.	4	WR-36	WR-36-BK	WR-36-BRN
		48"	2,500 lb.	5	WR-48	WR-48-BK	WR-48-BRN
7 1/8" x 1 1/16"	2 5/8" x 3/4"	24"	10,000 lb.	7	HCR-24	HCR-24-BK	HCR-24-BRN
		36"	10,000 lb.	8	HCR-36	HCR-36-BK	HCR-36-BRN
		48"	10,000 lb.	13	HCR-48	HCR-48-BK	HCR-48-BRN
9 1/8" x 1 1/2"	2 1/2" x 1 1/4"	36"	10,000 lb.	13	LHCR-36	LHCR-36-BK	LHCR-36-BRN
		48"	10,000 lb.	17	LHCR-48	LHCR-48-BK	LHCR-48-BRN
		60"	10,000 lb.	24	LHCR-60	LHCR-60-BK	LHCR-60-BRN
		72"	10,000 lb.	26	LHCR-72	LHCR-72-BK	LHCR-72-BRN
21 1/16" x 3 9/16"	4 1/2" x 3 1/8"	36"	10,000 lb.	51	XHCR-36	XHCR-36-BK	XHCR-36-BRN
		48"	10,000 lb.	58	XHCR-48	XHCR-48-BK	XHCR-48-BRN
		60"	10,000 lb.	72	XHCR-60	XHCR-60-BK	XHCR-60-BRN
		72"	10,000 lb.	88	XHCR-72	XHCR-72-BK	XHCR-72-BRN
OVERALL (W x H)	USABLE SPAN (W x H)	OVERALL LENGTH	SINGLE WHEEL CAPACITY	WEIGHT (POUND)	YELLOW	YELLOW / BLACK	
					MODEL NUMBER	MODEL NUMBER	
27/8" x 7/16"	1 1/4" x 5/16"	24"	2,500 lb.	2	WR-24-Y	WR-24-YB	
		36"	2,500 lb.	4	WR-36-Y	WR-36-YB	
		48"	2,500 lb.	5	WR-48-Y	WR-48-YB	
7 1/8" x 1 1/16"	2 5/8" x 3/4"	24"	10,000 lb.	7	HCR-24-Y	HCR-24-YB	
		36"	10,000 lb.	8	HCR-36-Y	HCR-36-YB	
		48"	10,000 lb.	13	HCR-48-Y	HCR-48-YB	
9 1/8" x 1 1/2"	2 1/2" x 1 1/4"	36"	10,000 lb.	13	LHCR-36-Y	LHCR-36-YB	
		48"	10,000 lb.	17	LHCR-48-Y	LHCR-48-YB	
		60"	10,000 lb.	24	LHCR-60-Y	LHCR-60-YB	
		72"	10,000 lb.	26	LHCR-72-Y	LHCR-72-YB	
21 1/16" x 3 9/16"	4 1/2" x 3 1/8"	36"	10,000 lb.	51	XHCR-36-Y	XHCR-36-YB	
		48"	10,000 lb.	58	XHCR-48-Y	XHCR-48-YB	
		60"	10,000 lb.	72	XHCR-60-Y	XHCR-60-YB	
		72"	10,000 lb.	88	XHCR-72-Y	XHCR-72-YB	

Urethane Hose & Cable Crossovers

Protect hoses and cables from everyday foot traffic. Handles loads up to 100 PSI (2,400 pounds) with less than 10% deflection. Constructed of durable urethane material. Designed with traction cleats on top surface to prevent slippage (for light traffic and slow applications only).

MODEL NUMBER	OVERALL SIZE (W x L)	USABLE SPAN (W x H)	UNIFORM CAPACITY	WEIGHT (POUND)
URTH-24 [Ⓢ]	23¼" x 23½"	3" x 3"	2,400 lb.	18
URTH-36 [Ⓢ]	23¼" x 35½"	3" x 3"	2,400 lb.	35
URTH-48 [Ⓢ]	23¼" x 47½"	3" x 3"	2,400 lb.	39



48 Hours
to Ship

Multi-Channel Cable Protectors

The fast and easy way to guard and protect valuable electrical cables and hose lines from damage and abuse while providing a method of safe crossing for vehicle and pedestrian traffic. Three channel design is ideal for construction sites, sporting events, and warehouses. Constructed of synthetic rubber with a yellow plastic lid. Ends include interlocking tabs for creating longer assemblies. Left and right sections ends are at 22½ degree. Four (4) left or four (4) right sections joined together form a 90 degree turn. Maximum weight loading capacity is 20,000 lb.

MODEL NUMBER	DESCRIPTION	CHANNEL SIZE (W x H)	OVERALL SIZE (W x L x H)	WEIGHT (POUND)
MCHC-3 [Ⓢ]	3-Channel CENTER Section	2 ³ / ₈ " x 2¼"	19¼" x 37½" x 2¼"	55
MCHC-3L [Ⓢ]	3-Channel LEFT Section	2 ³ / ₈ " x 2¼"	19¼" x 13¾" x 2¼"	28
MCHC-3R [Ⓢ]	3-Channel RIGHT Section	2 ³ / ₈ " x 2¼"	19¼" x 13¾" x 2¼"	28
MCHC-5 [Ⓢ]	5-Channel CENTER Section	1½" x 1 ³ / ₈ "	19¼" x 37½" x 3"	55
MCHC-5L [Ⓢ]	5-Channel LEFT Section	1½" x 1 ³ / ₈ "	19¼" x 13¾" x 3"	28
MCHC-5R [Ⓢ]	5-Channel RIGHT Section	1½" x 1 ³ / ₈ "	19¼" x 13¾" x 3"	28

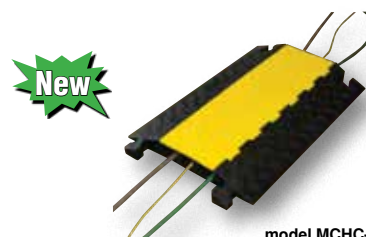

model MCHC-3

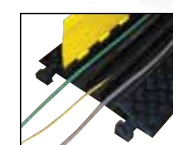

48 Hours
to Ship

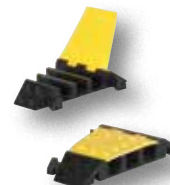

model MCHC-3R

Molded Rubber Hose & Cable Crossovers

Designed to protect cables and hoses from pedestrian and rolling traffic. The top surface of each crossover includes serrations for extra traction. Optional connectors may be used to interlock individual units together to form wider crossovers. Simply lock together as many units as required.

Model MRBR-24 has carrying handles molded into the ramp.

Fits over cables to protect hoses from punctures and kinks.

Series RHCB is ideal for people who are always switching out cables, but do not want to move the ramp. The model RHCB-A features an aluminum tread plate insert to protect hoses and cables (for light traffic and slow applications only).

MODEL NUMBER	OVERALL SIZE (W x L)	USABLE SPAN (W x H)	UNIFORM CAPACITY	WEIGHT (POUND)
MRBR-24 [Ⓢ]	24" x 23¼"	3" x 1½"	2,400 lb.	48
MRBR-CON [Ⓢ]		CONNECTOR PER PAIR		3
RHCB-12 [Ⓢ]	12" x 32 ⁵ / ₈ "	3½" x 2 ⁷ / ₈ "	2,400 lb.	33
RHCB-12A [Ⓢ]	12" x 32 ⁵ / ₈ "	3" x 2 ⁷ / ₈ "	2,400 lb.	38
RHCB-CON [Ⓢ]		CONNECTOR PER PAIR		2

48 Hours
to Ship



model MRBR-24



CONNECTORS



model RHCB-12

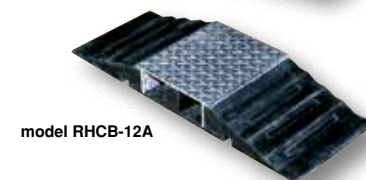

model RHCB-12A

Multi-Purpose Ramps

High impact ramps are perfect for a variety of work environments; postal routes, schools, hospitals, warehouses, and delivery routes. These ramps make it simple to move loads onto a curb or over hoses and cables. The textured non-skid surface allows for sure footing on the incline and decline. The lightweight and completely portable unit handles hand trucks and other wheeled equipment with ease.

MODEL NUMBER	MATERIAL	WIDTH	LENGTH	HEIGHT	UNIFORM CAPACITY	WEIGHT (POUND)
MPR-2310-G [Ⓢ]	PLASTIC	23¼"	10½"	3 ¹¹ / ₁₆ "	5,000 lb.	6
MPR-2313-G [Ⓢ]	PLASTIC	23¼"	13¼"	5½"	5,000 lb.	8
MPR-2410 [Ⓢ]	PLASTIC	24"	10 ⁵ / ₈ "	3 ⁷ / ₈ "	5,000 lb.	7
MRR-2310 [Ⓢ]	RUBBER	23¼"	10¼"	3 ⁹ / ₁₆ "	5,000 lb.	21
MPR-10-KIT [Ⓢ]	OPTIONAL BRIDGE KIT FOR MPR-2310-G, MPR-2410 or MRR-2310					6
MPR-13-KIT [Ⓢ]	OPTIONAL BRIDGE KIT FOR MPR-2313-G					6

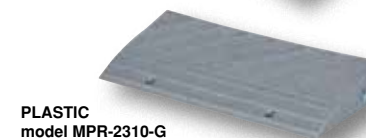

PLASTIC
model MPR-2310-G



BRIDGE KIT



PLASTIC
model MPR-2410

48 Hours
to Ship

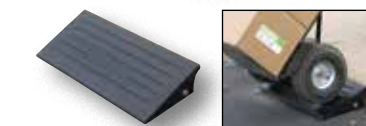

SOLID RUBBER, model MRR-2310

48 Hours
to Ship



model RCR-35

model RCR-C

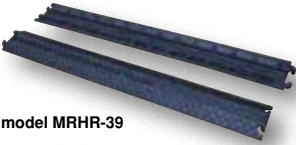

model MRHR-39

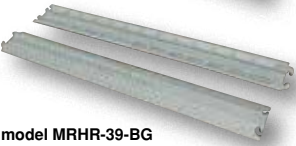

model MRHR-39-BG

48 Hours
to Ship

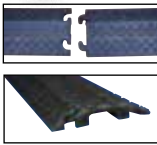

Rubber Ramps

Modular Rubber Ramps are versatile for use in many applications. Two (2) ramp lengths to choose from. Add round corner pieces for a finished look. Tread surface pattern for better traction. Includes hardware for connecting ramps together. Uniform capacity is 4,000 pounds per ramp. Heavy-duty molded rubber construction.

MODEL NUMBER	DESCRIPTION	WIDTH	DEPTH	HEIGHT	WEIGHT (POUND)
RCR-23 [Ⓢ]	RECTANGULAR RAMP	23 ⁵ / ₈ "	9 ¹¹ / ₁₆ "	3 ⁵ / ₈ "	16
RCR-35 [Ⓢ]	RECTANGULAR RAMP	34 ⁷ / ₈ "	9 ¹¹ / ₁₆ "	3 ⁵ / ₈ "	26
RCR-C [Ⓢ]	CORNER RAMP	9 ¹¹ / ₁₆ "	9 ¹¹ / ₁₆ "	3 ⁵ / ₈ "	28

Cable Guard

Designed to protect hose and cable from roll-over damage. Ideal for office and pedestrian applications. Interlocking design connects units for longer lengths. Top surface of ramp features anti-slip traction design. Manufactured from molded rubber.

MODEL NUMBER	COLOR	OVERALL SIZE (W x L x H)	USABLE SPAN (W x H)	UNIFORM CAPACITY	WEIGHT (POUND)
MRHR-39 [Ⓢ]	BLACK	5" x 39" x 3/4"	1 ⁷ / ₁₆ " x 1/2"	2,200 lb.	4
MRHR-39-YL [Ⓢ]	YELLOW	5" x 39" x 3/4"	1 ⁷ / ₁₆ " x 1/2"	2,200 lb.	4
MRHR-39-BG [Ⓢ]	BEIGE	5" x 39" x 3/4"	1 ⁷ / ₁₆ " x 1/2"	2,200 lb.	4



48 Hours
to Ship

model C-75-24

Long Extruded Rubber Cord Protectors

This product works well for temporary wire/cable protection from vehicles.

MODEL NUMBER	WIDTH (INCHES)	LENGTH (FEET)	HEIGHT (INCHES)	TOP OPENING	TWO BOTTOM OPENINGS	UNIFORM CAPACITY	WEIGHT (POUND)
C-75-12 [Ⓢ]	4"	12	1 ¹ / ₄ "	1/2"	5/8"	6,600 lb.	16
C-75-24 [Ⓢ]	4"	24	1 ¹ / ₄ "	1/2"	5/8"	6,600 lb.	33
C-150-12 [Ⓢ]	6 ¹ / ₂ "	12	2 ¹ / ₄ "	1 ¹ / ₂ "	1/2"	4,400 lbs.	39



New

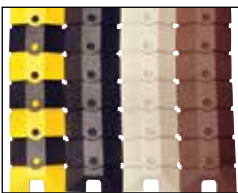

Sidewinder Cord Protector

The Sidewinder Cord Protector is an innovative new solution for protecting cords that run across a floor. The new design articulates left and right allowing the system to turn corners and adapt to the layout of the room, while maintaining full protection for the cords and trip protection for pedestrians. The cords can be left in the system and coiled around a three foot diameter for ultimate portability, or left in place indefinitely. There is no longer a compromise between safety and flexibility.

MODEL NUMBER	COLOR	END CAPS INCLUDED	OVERALL SIZE (W x L x H)	USABLE SPAN (W x H)	WEIGHT (POUND)
SWCP-3-YB	Yellow/Black	Yes	3" x 40" x 3/4"	3/4" x 3/8"	6
SWCP-1X-YB	Yellow/Black	No	3" x 12" x 3/4"	3/4" x 3/8"	4
SWCP-3-BK	Black	Yes	3" x 40" x 3/4"	3/4" x 3/8"	6
SWCP-1X-BK	Black	No	3" x 12" x 3/4"	3/4" x 3/8"	4
SWCP-3-BRN	Brown	Yes	3" x 40" x 3/4"	3/4" x 3/8"	6
SWCP-1X-BRN	Brown	No	3" x 12" x 3/4"	3/4" x 3/8"	4
SWCP-3-GY	Grey	Yes	3" x 40" x 3/4"	3/4" x 3/8"	6
SWCP-1X-GY	Grey	No	3" x 12" x 3/4"	3/4" x 3/8"	4
SWCP-3-YB-M	Yellow/Black	No	9 ³ / ₄ " x 40" x 1 ³ / ₈ "	3" x 3/4"	7
SWCP-1X-YB-M	Yellow/Black	No	9 ³ / ₄ " x 12" x 1 ³ / ₈ "	3" x 3/4"	3
SWCP-3-BK-M	Black	No	9 ³ / ₄ " x 40" x 1 ³ / ₈ "	3" x 3/4"	7
SWCP-1X-BK-M	Black	No	9 ³ / ₄ " x 12" x 1 ³ / ₈ "	3" x 3/4"	3
SWCP-3-YB-L	Yellow/Black	No	13 ⁵ / ₈ " x 40" x 2 ¹ / ₈ "	3" x 1 ¹ / ₂ "	14
SWCP-1X-YB-L	Yellow/Black	No	13 ⁵ / ₈ " x 12" x 2 ¹ / ₈ "	3" x 1 ¹ / ₂ "	5
SWCP-3-BK-L	Black	No	13 ⁵ / ₈ " x 40" x 2 ¹ / ₈ "	3" x 1 ¹ / ₂ "	14
SWCP-1X-BK-L	Black	No	13 ⁵ / ₈ " x 12" x 2 ¹ / ₈ "	3" x 1 ¹ / ₂ "	5

Hitch Lift

Heavy-duty 12 volt DC motorized hitch lift. Standard 2" receiver bar has multiple pin positions for different tailgate depths (extends out 52" when lowered and 47" when raised). Built-in adjustable limiting device to allow the matching up of the deck plate to the truck bed level or to ground level. 21 foot long cable set for battery connection. Two stage outrigger assemblies for added stability. Be sure to fold the deck plate up before driving away. Tie down straps should be used to secure load. Steel construction.

MODEL NUMBER	PLATFORM SIZE (W x L)	RAMP (W x L)	UNIFORM CAPACITY	WEIGHT (POUND)
HL-55	28" x 25"	28" x 7"	500 lb.	187

48 Hours
to Ship



Wheel Alignment Curbs

Ideal for properly aligning trailers at loading docks. All welded steel construction suitable for indoor or outdoor use. Units must be secured to surface. Heavy-duty welded-steel construction with yellow baked-in powder-coated toughness. 8" x 8" base plates with (8) pre-drilled holes standard.

MODEL NUMBER	HEIGHT	CURB LENGTH	DIAMETER	WEIGHT (POUND)
SWAC-92	8 ^{15/16} "	92"	4 ^{1/2} "	81
SWAC-144	8 ^{15/16} "	144"	4 ^{1/2} "	173
AS-344	(1) 3/4" x 4/4" CONCRETE ANCHOR BOLT			1
AS-344-4PK	(4) 3/4" x 4/4" CONCRETE ANCHOR BOLTS			4

POWDER COATED TOUGH

48 Hours
to Ship



Heavy Duty LED Dock Loading Lights 115V 1-PHASE STANDARD

Rugged, heavy duty LED Dock Loading Lights provides brighter light than an incandescent light source while only using 18 watts of power. Encased in a cast aluminum housing with shatter resistant polycarbonate lens cover, this unit instantly reaches maximum light output. Light head is IP66 rated; can be sprayed down. Expected life of 50,000+ hours; 3 year warranty. UL listed.

MODEL NUMBER	DESCRIPTION	ARM LENGTH	LIGHT BULB INCLUDED	WEIGHT (POUND)
LL-HD-LED-24	SINGLE ARM	24"	YES	17
LL-HD-LED-40	DOUBLE ARM	40"	YES	25
LL-HD-LED-60	DOUBLE ARM	60"	YES	28
LL-HD-LED-90	DOUBLE ARM	90"	YES	38

New

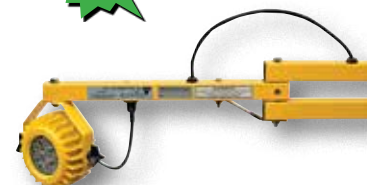

LED Dock Loading Lights 115V 1-PHASE STANDARD

Reduce broken bulb and high maintenance costs with LED Dock Loading Lights. These use 80% less energy than incandescent or halogen bulb. Achieves maximum light intensity instantly, and light is optimized for trailer illumination. These LED lights have no fragile filaments to break, eliminating the shattered glass of broken incandescent bulb. Light bulb included.

MODEL NUMBER	DESCRIPTION	ARM LENGTH	LIGHT BULB INCLUDED	WEIGHT (POUND)
LL-LED-24	SINGLE STRUT	24"	YES	11
LL-LED-40	DOUBLE STRUT	40"	YES	15
LL-LED-60	DOUBLE STRUT	60"	YES	18
LL-LED-BULB	REPLACEMENT LED BULB			2



model LL-LED-40

vestil
green

Flexible Gooseneck Dock Lights 115V 1-PHASE STANDARD

Low profile, flexible task light, ideally suited for loading dock applications. Its 27" flexible stainless steel neck can be easily rotated and positioned to light with minimal obstruction to the loading dock area. The dock lights narrow profile and flexibility enable it to be mounted between two (2) neighboring loading dock positions. With the simple mounting method and ability to be positioned precisely, it is an ideal task light for use around work stations and machinery. UL listed.

MODEL NUMBER	DESCRIPTION	ARM LENGTH	LIGHT BULB INCLUDED	WEIGHT (POUND)
LL-GN-27	INCANDESCENT (90 WATT)	27"	NO	10
LL-GN-LED-27	LED	27"	YES	10



model LL-GN-27



New

model LL-GN-LED-27

Dock Loading Lights 115V 1-PHASE STANDARD



Lights minimize freight damage, while expediting loading and unloading operations. Designed to provide uniform visibility inside trailers or around dock areas. Model LL-SAI and LL-SAF are ETL C/U.S. listed, while all others are UL listed.

Incandescent Lights, series LL. offer good color, low replacement cost, and turn on instantly even in cold environments. It utilizes a 90 watt bulb, model *PAR-38-90*, sold separately. Adjustable arm knuckle joint allows vertical and horizontal positioning.

Halogen Light, model HLGN-40, typically provides more lumens/watt, better energy efficiency, has a longer service life, and experiences less light depreciation over its lifetime. It is supplied with a 500 watt bulb. Full illumination is instantaneous.

High Pressure Sodium Lights, series LLS and AALLS, offer much higher lumens/watt output and a very long lamp life. Its illumination color rendition (yellowish) is not as desirable as an incandescent. They typically require several minutes to fully illuminate, and even longer if in a cold environment. Low operating cost.

Spun Aluminum Dock Lights, series LL-SAI, stay cool to the touch even with a 300 watt incandescent light. Features strut arm with both horizontal and vertical adjustment. Available in a standard incandescent lamp head and a fluorescent lamp head. Fluorescent units include a bulb and head.



INCANDESCENT SINGLE ARM model LL-24



INCANDESCENT DOUBLE ARM model LL-40



INCANDESCENT DOUBLE ARM model LL-60



HALOGEN DOUBLE ARM model HLGN-40



INCANDESCENT series LL-SAI

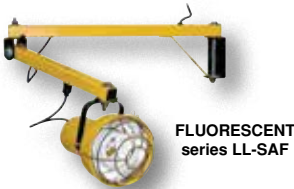

FLUORESCENT series LL-SAF



HIGH PRESSURE SODIUM model LLS-40



model HLGN-PWL



model HLGN-FWL

	MODEL NUMBER	DESCRIPTION	LENGTH	WEIGHT (POUND)
DRY LOCATIONS	LL-24 [Ⓢ]	INCANDESCENT, SINGLE ARM	24"	14
	LL-40 [Ⓢ]	INCANDESCENT, DOUBLE ARM	40"	16
	LL-60 [Ⓢ]	INCANDESCENT, DOUBLE ARM	60"	21
	LL-90 [Ⓢ]	INCANDESCENT, TRIPLE ARM	90"	30
	LL-SAI-40	INCANDESCENT, SINGLE STRUT ARM	40"	11
	LL-SAI-60	INCANDESCENT, SINGLE STRUT ARM	60"	15
	HLGN-40 [Ⓢ]	HALOGEN, DOUBLE ARM	40"	16
	LL-SAF-40	FLUORESCENT, SINGLE STRUT ARM	40"	11
DAMP LOCATIONS	LL-SAF-60	FLUORESCENT, SINGLE STRUT ARM	60"	15
	LLS-24	HIGH PRESSURE SODIUM, SINGLE ARM	24"	10
	LLS-40	HIGH PRESSURE SODIUM, DOUBLE ARM	40"	18
	LLS-60	HIGH PRESSURE SODIUM, DOUBLE ARM	60"	21
	LLS-90	HIGH PRESSURE SODIUM, TRIPLE ARM	90"	30
	AALLS-40	HIGH PRESSURE SODIUM, ADJUSTABLE ARM	40"	17
	AALLS-60	HIGH PRESSURE SODIUM, ADJUSTABLE ARM	60"	19

	MODEL NUMBER	DESCRIPTION	WEIGHT (POUND)
DOCK LOADING LIGHT OPTIONS	PAR-38-90 [Ⓢ]	90 WATT HALOGEN BULB, 1270 LUMENS (LL)	1
	LL-S-BULB	SODIUM BULB - 50 WATT	2
	LL-FL-BULB	FLUORESCENT BULB - 55 WATT	2
	LL-S-HEAD	SODIUM HEAD ONLY	2
	LL-WG [Ⓢ]	WIRE GUARD - 6" DIAMETER (INCANDESCENT)	2
	LL-GRILL	GRILL / DIFFUSER (SODIUM)	5
	LL-STAND	LIGHT STAND, 83" HIGH, INCLUDES ADJUSTABLE BRACKET	60
	LLF-18 [Ⓢ]	18" FAN, MOUNTING BRACKETS AND POWER CORD	20
	LL-40-FAN [Ⓢ]	PACKAGE: LL-40 LIGHT, FAN, BRACKETS AND WIRING	37

Halogen Work Lights 115V 1-PHASE STANDARD

Superior lighting at the job-site assures worker safety plus accurate loading and unloading. These premium lights are UL listed and CSA certified. 500 watt halogen bulb included providing 11,000 lumens. Model HLGN-PWL is adjustable in height from 40" to 60½".

MODEL NUMBER	DESCRIPTION	MOUNTING STYLE	LIGHT BULBS	WEIGHT (POUND)
HLGN-FWL [Ⓢ]	SINGLE LAMP	FLOOR	500 WATT	5
HLGN-PWL [Ⓢ]	DOUBLE HEAD / DOUBLE CLAMP	PEDESTAL	500 WATT	12



Easy to use ratchet mechanism allows one person to adjust and ratchet into place.

Cargo Bars

- Keep trailer contents in place - eliminate damaged goods
- Simple mechanical lock - will not vibrate loose



During transport, keep trailer contents securely in place with these easy to use Cargo Bars. Constructed of 1½" square tubing, unless specified. 14 gauge wall construction is lightweight, yet extremely strong. Square articulating steel end plates feature rubber pads for positive gripping action. End plates measure 4" x 4" on models CL-15, CL-16 and CL-17. End plates measure 4" x 2¾" on model CB-7 & CB-7-S and 3¾" x 3¾" on model CL-18 and CBH-32. Bars fit between trailer walls.



TYPE	MODEL NUMBER	DESCRIPTION	SERVICE RANGE	WEIGHT (POUND)
A	CB-5	ONE PIECE ALUMINUM (ROUND TUBE)	88" to 103"	8
A	CB-7	ONE PIECE ALUMINUM Heavy-Duty (ROUND TUBE)	89" to 104"	9
C	EB-96	ONE PIECE ALUMINUM (E-TRACK)	85" to 96"	19
C	EB-102	ONE PIECE ALUMINUM (E-TRACK)	92" to 102"	21
D	CB-7-S	ONE PIECE STEEL (ROUND TUBE)	89" to 104"	12
E	CL-15	ONE PIECE STEEL	87" to 119"	15
E	CL-16	ONE PIECE STEEL GALVANIZED	87" to 119"	15
F	CL-17	TWO PIECE STEEL GALVANIZED (FOLDING)	88" to 116"	17
G	CL-18	TWO PIECE STEEL GALVANIZED (TELESCOPIC)	90 ³ / ₈ " to 139 ⁹ / ₁₆ "	24
H	CL-20	TWO PIECE STEEL E & A TRACK (FOLDING)	87" to 116"	18
I	CB-PU-3	ONE PIECE STEEL TRUCKS/VANS (ROUND TUBE)	40" to 70"	5
J	CBH-32	ONE PIECE STEEL WITH FULL HOOPS	87" to 116"	28
K	CH-7	GALVANIZED HOOPS (FOR CB SERIES ONLY)	30½"W x 23½"H	16
L	CH-3	GALVANIZED HOOPS (FOR CL SERIES ONLY)	31"W x 24½"H	15
M	E-TRACK	STEEL SECTION OF E-TRACK FOR TRAILERS	10 FOOT	16
N	CB-HLDR	CARGO BAR HOLDER	--	7

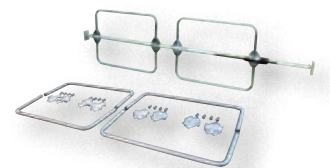

K & L) Cargo Bar Hoops model CH-7 for CB series Cargo Bars model CH-3 for CL series Cargo Bars (cargo bars sold separately, hoops sold in pairs)

Truck Mounted Strap Winches

Tighten down loads to eliminate shifting. Choose from either weld or bolt on design. Strap and chrome plated winch bar sold separately. Low profile design available. Accommodates 4" straps up to 30' long.

MODEL NUMBER	DESCRIPTION	OVERALL SIZE (W x L x H)	WEIGHT (POUND)
SW-4-PSW	WELD ON WINCH	3½" x 7¾" x 6¼"	10
SW-4-PSB	BOLT ON WINCH	3½" x 7¾" x 6¼"	11
SW-BAR	MULTI-TASK WINCH BAR	1¾" DIA. x 34½"L	7
SW-BAR-PT	PAINTED WINCH BAR	1¾" DIA. x 34½"L	8
STRAP-30	30 FOOT STRAP	4" W x 30'L	7

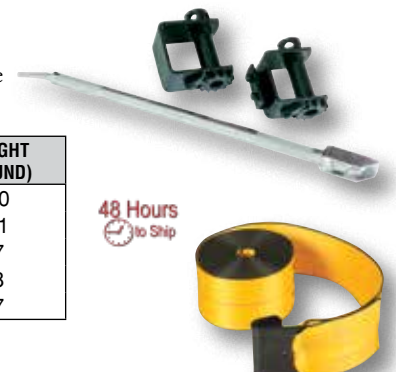

30 FOOT STRAP model STRAP-30



RATCHET TYPE
model LBDR-9-L

LEVER TYPE
model LBDR-13-L

Lockable Load Binders

- Provides 5,400 lb. working load limit
- Ideal for trailers, campers, or farm equipment

Used for chain binding applications in trucking and marine industries. Heavy-duty, forged steel construction. Uniform proof capacity is 10,000 pounds. Ultimate uniform capacity is 19,000 pounds. Accommodates 5/16" to 3/8" chain. Insert lock through hole for maximum theft protection.

MODEL NUMBER	DESCRIPTION	TAKE UP	WEIGHT (POUND)
LBDR-9-L	LEVER	3 3/4"	15
LBDR-13-L	RATCHET	3"	12



model
PCD-92

Pallet Cargo Decker

Reduce freight damage while protecting delicate cargo with our Pallet Cargo Decker. Fits into standard semi-trailers and allows an increase in trailer load volume where wasted space once was. Holds boxes, pallets, and other freight. 5,000 lb. uniform capacity. Wood platform not included.

MODEL NUMBER	DESCRIPTION	OVERALL SIZE (W x H x D)	WEIGHT (POUND)
PCD-92	SINGLE	90 1/4" x 56" x 49 1/2"	356
PCD-92D	DOUBLE DECKER	90 1/4" x 56" x 49 1/2"	482
PCD-92DS	DOUBLE WITH SIDES	90 1/4" x 56" x 49 1/2"	643
PCD-92DSB	DOUBLE W/SIDES & BACK	90 1/4" x 56" x 49 1/2"	795
PCD-STL	OPTIONAL 10 GAUGE STEEL PLATFORM		150



model
BAG-4836

48 Hours
to Ship



AIR BAG INFLATION VALVE • model BAG-I

Reusable Dunnage Bags

Minimize product shifting and damage in transit. The 2-ply construction consists of a polypropylene weave outer bag protecting a polyethylene inner bag. The bag provides 6 psi pressure seal. Stores flat when empty. Fill with standard shop air.

Air Bag Inflation Valve tool offers easy grip for convenient use. Press and hold red vinyl coated lever. The cast zinc body has a chrome plated finish. Air inlet thread female 1/4" NPT.

MODEL NUMBER	DESCRIPTION	SIZE (W x H)	WEIGHT (POUND)
BAG-4836	REUSABLE BAG	48" x 36"	2
BAG-4884	REUSABLE BAG	48" x 84"	2
BAG-I	AIR BAG INFLATION VALVE		1



model STRAP-12-RE

model STRAP-16-CE

model STRAP-27-RH

model STRAP-27-FH



model STRAP-15-RTB

model STRAP-6-RTB

model STRAP-6-RTO

Cargo Strapping & Guards

Guard against damages from slipping and shifting loads while transporting products. Spring loaded e-track fittings provide quick one-handed connection to anchor point. Both ratchet and cam buckle models tighten and release quickly. Edge Guards are reusable, durable, and economical. Tough strapping fabric is made of a polyester webbing. Model TARP-C promotes the life of your tarps and protect sharp product corners.



model E-CLIP-W

model E-CLIP-D



model
EDGE-R6 & EDGE-S7

48 Hours
to Ship

New

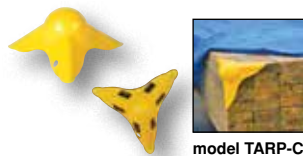

model TARP-C

MODEL NUMBER	STRAP WIDTH	WORKING LENGTH	UNIFORM WORKING LOAD	TIGHTENING MECHANISM	FASTENER	WEIGHT (POUND)
STRAP-12-RE	2"	12'	1,000 lbs.	RATCHETING	E-CLIP	2
STRAP-16-CE	2"	16'	1,200 lbs.	CAM	E-CLIP	4
STRAP-16-RE	2"	16'	1,200 lbs.	RATCHETING	E-CLIP	3
STRAP-27-RH	2"	27'	3,325 lbs.	RATCHETING	ROD HOOK	6
STRAP-27-FH	2"	27'	3,325 lbs.	RATCHETING	FLAT HOOK	6
STRAP-6-RTO	2"	6"	800 lbs.	D-RING/STRAP	E-CLIP	2
STRAP-15-RTB	1"	15'	1,500 lbs.	RETRACTABLE	HOOKS	2
STRAP-6-RTB	1"	6'	1,500 lbs.	RETRACTABLE	HOOKS	2
ROPE-8-TD	1/4"	8'	150 lbs.	TIE-DOWN	HOOKS	2
E-CLIP-W	BEAM E-SOCKET SUPPORTS THE END OF WOOD 2 x 4					2
E-CLIP-D	TIE OFF THE "D" RING WHEN ATTACHED TO THE E-TRACK					2
EDGE-R12	RUBBER EDGE GUARDS, 5 3/4"W x 12"L, 50 PIECES PER PACKAGE					37
EDGE-R6	RUBBER EDGE GUARDS, 4 3/4"W x 6"L, 100 PIECES PER PACKAGE					31
EDGE-S7	STEEL EDGE GUARDS, 7 1/2"W x 4 7/8"L, 10 PIECES PER PACKAGE					15
TARP-C	RECYCLE MOLDED PLASTIC, 6 7/8"W x 5 1/2"L, 16 PIECES PER PKG.					3

Quilted Moving Pads

Cushion and protect furniture, machinery, and electronic equipment. Each pad measures 72" wide by 80" long. Model QPC-7280-UP is water and mildew resistant.

MODEL NUMBER	DESCRIPTION	QUANTITY	WEIGHT (POUND)
QPC-7280-DP	GENERAL DUTY (cotton)	12	57
QPC-7280-UP	ALL WEATHER (polyester)	12	63
QPC-7280-VP	HEAVY-DUTY (polyester/cotton)	12	82
QPC-7280-UP-1PK	ALL WEATHER (polyester)	1	9
QPC-7280-UP-4PK	ALL WEATHER (polyester)	4	30



GENERAL DUTY QPC-7280-DP



ALL WEATHER QPC-7280-UP



HEAVY DUTY QPC-7280-VP



Rubber Wheel Chocks

Constructed of reinforced rubber to provide a sure grip on virtually any surface. Curved surface contours to fit tires. Rubber resists tearing, abrasion, ozone weathering, etc. Functional design is durable in all weather conditions. Series RWC-8 is constructed of a mix of virgin and recycled, no reinforcement cords.

The Airline Chocks are suitable for small and large aircraft. Model AC-13 includes a 36" long polypropylene rope, while model AC-18 has a 14" long polypropylene rope between the chocks.

TYPE	MODEL NUMBER	DESCRIPTION	WHEEL CHOCK (W x H x L)	WEIGHT (POUND)
A	LWC-15	LAMINATED RUBBER	7 1/2" x 11" x 5 1/2"	13
B	LWC-14	LAMINATED RUBBER (HANDLE)	9 1/2" x 5 1/2" x 12 3/8"	17
C	LWC-14M	LAMINATED RUBBER (HANDLE W/RUBBER GRIPS)	9 1/2" x 5 1/2" x 12 3/8"	19
D	RWC-2-PR	MOLDED RUBBER (W/64"L ROPE CONNECTED)	5" x 4" x 8"	10
E	RWC-3	MOLDED RUBBER (HANDLE)	8" x 4" x 8"	6
F	RWC-5	MOLDED RUBBER (MOLDED HANDLE)	4" x 6" x 8"	5
G	RWC-8	MOLDED RUBBER (EYEBOLT)	9 1/4" x 6" x 8"	11
H	RWC-8/OH-15-HD	MOLDED RUBBER (2 CHOCKS & (2) 15' CHAINS)	9 1/4" x 6" x 8"	18
I	RWC-8-HDL	MOLDED RUBBER (HANDLE)	9 1/4" x 6" x 8"	12
J	ORWC-8-HDL	MOLDED RUBBER (ORANGE)	9 1/4" x 6" x 8"	11
K	RWC-9-U	MOLDED RUBBER ("U" HANDLE)	9 1/4" x 6" x 8"	11
L	RWC-8-SBS	MOLDED RUBBER (SERRATED BOTTOM)	9 1/4" x 6" x 8"	10
M	RWC-10-HDL	MOLDED RUBBER (POSITIONING HANDLE)	9 1/2" x 4 7/8" x 7 3/8"	12
N	RWC-11	MOLDED RUBBER	7" x 7 3/4" x 10"	11
O	RWC-25	MOLDED RUBBER (JUMBO)	16" x 8" x 12"	25
P	RMC-4	EXTRUDED RUBBER	6 1/2" x 4 3/4" x 4 1/4"	5
R	EX-4	EXTRUDED RUBBER	10" x 3 3/4" x 4 1/2"	5
S	EX-11	EXTRUDED RUBBER	8 1/2" x 6" x 8 1/2"	14
T	EX-13	EXTRUDED RUBBER	12" x 5 3/4" x 6 1/2"	18
U	AC-13	AIRLINE CHOCK WITH ROPE	10" x 4 1/2" x 5"	12
W	AC-18	AIRLINE CHOCK WITH ROPE	18" x 5 1/2" x 6"	36

*TRUCK MOUNTED WHEEL CHOCK HOLDER AVAILABLE, model TMCH-RWC-8, SEE PAGE A35



A) LWC-15



B) LWC-14



C) LWC-14M

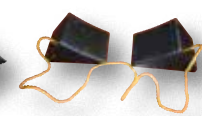

D) RWC-2-PR



E) RWC-3



F) RWC-5

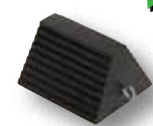

G) RWC-8

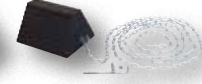

H) RWC-8/OH-15-HD

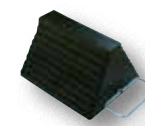

I) RWC-8-HDL

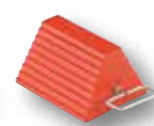

J) ORWC-8-HDL

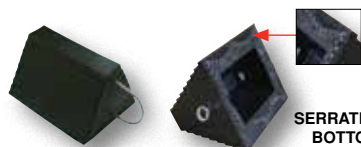

K) RWC-9-U

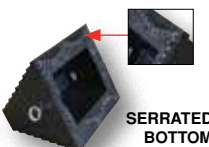

L) RWC-8-SBS



M) RWC-10-HDL

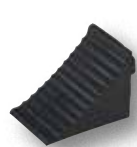

N) RWC-11



O) RWC-25



P) RMC-4



R) EX-4



S) EX-11



T) EX-13

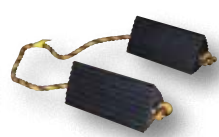

U) AC-13

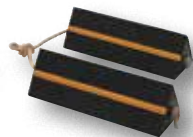

W) AC-18





model PWC-G



model PWC-Y

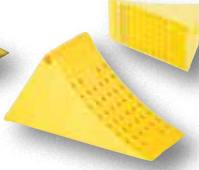

model PLWC-Y

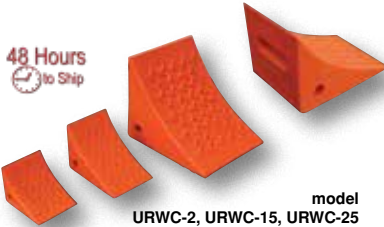

model URWC-2, URWC-15, URWC-25

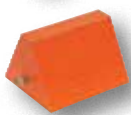

model URWC-8

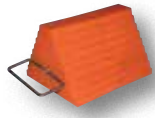

model URWC-8-HDL



model URWC-25



BOTTOM VIEW
model URWC-25-SS

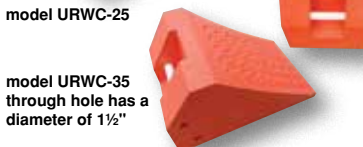

model URWC-35
through hole has a diameter of 1/2"



G) FAB-8

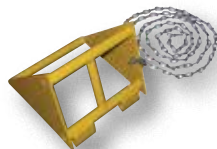

H) FAB-10



I) FAB-11



J) MS-15



K) SSC-17



M) GWC-10

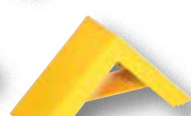

L) SWC-22

Plastic Wheel Chocks

These plastic wheel chocks are durable yet light enough to take along when you travel. Series *PWC*, is made of 100% recycled plastic. Resistant to damage from sunlight, oil, salt, and chemicals. Features a molded-in handle with (2) two 1 3/8" thru holes. Holes will accommodate OH-15 chain attachment (not included).

Model *PLWC-Y*, features a molded-in handle. Bottom surface includes three (3) steel cleats for extra traction.

Series *PWC-DS*, features a dual slope. One side has a 45° slope while the other side has a 60° slope. 100% recycled plastic construction is chemical and sunlight resistant and delivers a strong grasp to a number of surfaces. Comes standard with a eyebolt.

MODEL NUMBER	DESCRIPTION	WHEEL CHOCK (W x H x D)	COLOR	WEIGHT (POUND)
PWC-G [Ⓢ]	RECYCLED PLASTIC	7 1/2" x 7 1/2" x 10 1/4"	GREEN	7
PWC-Y [Ⓢ]	RECYCLED PLASTIC	7 1/2" x 7 1/2" x 10 1/4"	YELLOW	7
PWC-O	RECYCLED PLASTIC	7 1/2" x 7 1/2" x 10 1/4"	ORANGE	7
PWC-BK	RECYCLED PLASTIC	7 1/2" x 7 1/2" x 10 1/4"	BLACK	7
PLWC-Y [Ⓢ]	MOLDED PLASTIC	7 1/4" x 9" x 18 1/2"	YELLOW	6
PWC-DS-YL [Ⓢ]	RECYCLED PLASTIC	9 1/4" x 6" x 11"	YELLOW	13
PWC-DS-OR [Ⓢ]	RECYCLED PLASTIC	9 1/4" x 6" x 11"	ORANGE	13
PWC-DS-BK [Ⓢ]	RECYCLED PLASTIC	9 1/4" x 6" x 11"	BLACK	13

Urethane Wheel Chocks

Bright orange for greater visibility. Incoming and outgoing drivers can easily see chock for added safety. Tread on chock face provides better grip and reduces slippage.

MODEL NUMBER	DESCRIPTION	WHEEL CHOCK (W x H x L)	WEIGHT (POUND)
URWC-2* [Ⓢ]	MINI-URETHANE CHOCK	7" x 6" x 8"	3
URWC-8 [Ⓢ]	URETHANE CHOCK (EYEBOLT)	9 1/2" x 8" x 6"	3
URWC-8-HDL [Ⓢ]	URETHANE WITH HANDLE	9 1/2" x 8" x 6"	4
URWC-15* [Ⓢ]	URETHANE WHEEL CHOCK	8" x 8" x 11"	5
URWC-25* [Ⓢ]	JUMBO URETHANE CHOCK	14 1/2" x 14 1/2" x 17"	21
URWC-25-SS* [Ⓢ]	JUMBO CHOCK W/STEEL STUDS	14 1/2" x 14 1/2" x 17"	22
URWC-35* [Ⓢ]	SUPER URETHANE CHOCK	14" x 14" x 24"	31
URWC-45* [Ⓢ]	MEGA URETHANE CHOCK	18" x 18" x 24"	32

*MOLDED HOLE THROUGH WIDTH OF CHOCK FOR ATTACHING CHAIN (not included)

Steel Wheel Chocks

- G) Textured tread plate to provide maximum traction.
- H) Open face radius allows chock to be used with any size tire. Includes 10 ft. chain.
- I) Formed chock utilizes a saw tooth bottom for traction.
- J) Features grip slot for easy pick up and positioning.
- K) Slope design contours to truck wheel.
- L) Rugged all welded construction. Works in mud, sand, or concrete.
- M) Serrated steel wheel chock, grate style, 11 1/4" D including handle, galvanized finish, includes positioning handle with grip.

TYPE	MODEL NUMBER	DESCRIPTION	WHEEL CHOCK (W x H x L)	WEIGHT (POUND)
G	FAB-8 [Ⓢ]	WELDED STEEL CHOCK	7 1/2" x 8" x 8"	7
H	FAB-10 [Ⓢ]	FABRICATED STEEL CHOCK	9 13/16" x 8 1/4" x 9 15/16"	11
I	FAB-11 [Ⓢ]	FORMED STEEL CHOCK	8" x 9" x 10 3/4"	11
J	MS-15 [Ⓢ]	MOLDED CAST STEEL CHOCK	8 9/16" x 7 3/16" x 8 1/4"	16
K	SSC-17 [Ⓢ]	CAST STEEL SLOPE CHOCK	8 3/4" x 8 1/2" x 15 1/2"	25
L	SWC-22 [Ⓢ]	STEEL WHEEL CHOCK	6" x 9 1/16" x 17 5/16"	19
M	GWC-10* [Ⓢ]	SERRATED STEEL CHOCK	9" x 4 7/8" x 11 1/4"	11

*14" DEEP INCLUDING HANDLE

Aluminum Wheel Chocks

Extruded lightweight aluminum that is easy to handle. Features a serrated top to grip the tire and a triple edged bottom to grip the ground. Optional handle and sign attachment available.

TYPE	MODEL NUMBER	DESCRIPTION	WHEEL CHOCK (W x H x L)	WEIGHT (POUND)
A	EALUM-7 [Ⓢ]	CHOCK	7" x 8" x 11 ³ / ₄ "	8
B	EALUM-7-HNDG	CHOCK WITH HAND GRIP	7" x 8" x 13 ¹ / ₁₆ "	7
C	EALUM-YEL [Ⓢ]	YELLOW CHOCK	7" x 8" x 11 ³ / ₄ "	8
D	EALUM-7-H [Ⓢ]	CHOCK WITH HANDLE	7" x 7 ¹¹ / ₁₆ " x 11 ⁷ / ₈ "	13
E	EALUM-7-HS [Ⓢ]	CHOCK W/HANDLE / SIGN	7" x 7 ¹¹ / ₁₆ " x 11 ⁷ / ₈ "	13
F	CWS-13	CHOCK W/FLAG	7" x 8" x 11 ⁷ / ₈ "	16



A) EALUM-7 B) EALUM-7-HNDG C) EALUM-YEL



F) CWS-13

D) EALUM-7-H E) EALUM-7-HS



Ergo-Handle Wheel Chocks

Ergonomically designed to make it easy to move wheel chocks in and out of position under trailer wheels. Reduce the risk of back, knee, and foot injuries. Handle is constructed of steel and includes a yellow baked-in powder-coated toughness. Assembly required.

MODEL NUMBER	TYPE OF WHEEL CHOCK	WHEEL CHOCK (W x H x D)	WEIGHT (POUND)
RWC-8-ERGO [Ⓢ]	MOLDED RUBBER, BLACK	9 ¹ / ₄ " x 6" x 8"	16
ORWC-8-ERGO [Ⓢ]	MOLDED RUBBER, ORANGE	9 ¹ / ₄ " x 6" x 8"	11
LWC-14M-ERGO	LAMINATED RUBBER	9 ¹ / ₂ " x 5 ¹ / ₂ " x 10 ¹ / ₈ "	24
FAB-10-ERGO	FABRICATED STEEL	9 ¹³ / ₁₆ " x 8 ¹ / ₄ " x 9 ¹ / ₂ "	17
FAB-11-ERGO	FABRICATED STEEL	8" x 9 ¹ / ₈ " x 10 ³ / ₄ "	13



model RWC-8-ERGO

model FAB-11-ERGO

Wheel Chock Accessories

Chain and Hangers - Discourage theft and misplacement of wheel chocks. Facilitate safety in the dock area. 15 foot chain attaches to the hanger. Hanger is then secured to the dock wall. Chain is fastened to the chock with cold shut.

Nylon Straps - Bright red / yellow in color for ease to see. Strap end includes large loop for easy pulling and carrying. Easily attach to chock using small choker loop. Longer 15' strap includes second loop for attachment of second wheel chock. Both chocks can be removed from the same side of the trailer.

Wheel Chock Holders - Keep wheel chocks safe and prepared for use at any moment. The holder features steel construction for long life and durability, baked-in powder-coated toughness for visibility and predrilled mounting holes for easy attachment. Model WC-H-R includes a vinyl sticker attached to front of holder which reads "The Law Says CHOCK YOUR WHEELS".

Wheel Chock Warning Signs - Warn truck drivers and dock workers to chock their wheels as required by law. Weather resistant. Bright red lettering provides high visibility. Sign has four (4) mounting holes. Reflective sign is available for docks open at dawn and dusk. Signs and Vinyl Sticker measure 11³/₄" W x 9³/₄" H. More signs available in Facility Maintenance section.

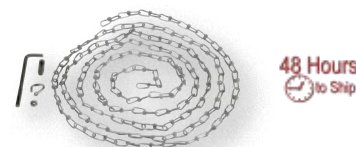

CHAIN & HANGER
model OH-15



NYLON STRAP
model STRAP-3-WC

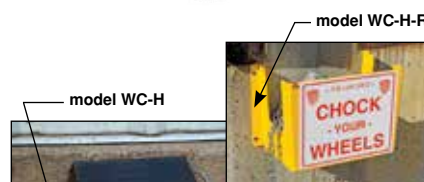

model WC-H

model WC-H-R

WHEEL CHOCK
HOLDERS
WHEEL CHOCK
SOLD SEPARATLY



WARNING SIGN
model SA-1012

POWDER
COATED
TOUGH



TRUCK MOUNTED
WHEEL CHOCK HOLDER
model TMCH-RWC-8

MODEL NUMBER	DESCRIPTION	WEIGHT (POUND)
OH-15 [Ⓢ]	#2 DOUBLE LOOP COIL CHAIN WITH HANGER	3
OH-15-YEL	#2 CHAIN WITH HANGER WITH POWDER-COAT YELLOW	3
OH-15R [Ⓢ]	#2 CHAIN & HANGER WITH REFLECTOR	4
OH-HD [Ⓢ]	HD PROOF COIL CHAIN (³ / ₁₆ " THICK) W/HANGER	7
OH-15-STRAP [Ⓢ]	15 FOOT NYLON STRAP & HANGER KIT	3
STRAP-3-WC [Ⓢ]	3 FOOT NYLON STRAP	2
STRAP-15-WC [Ⓢ]	15 FOOT NYLON STRAP	4
WC-H	WHEEL CHOCK HOLDER (CAPACITY 40 LBS. / USABLE WIDTH 10 ³ / ₄ ")	3
WC-H-R	DELUXE WHEEL CHOCK HOLDER (CAPACITY 40 LBS.)	9
TMCH-RWC-8*	TRUCK MOUNTED WHEEL CHOCK HOLDER	8
SA-1012 [Ⓢ]	ALUMINUM WHEEL CHOCK SIGN	1
SF-1012 [Ⓢ]	REFLECTIVE ALUMINUM WHEEL CHOCK SIGN	1
SV-1012 [Ⓢ]	VINYL WHEEL CHOCK STICKER	2

*USE WITH RUBBER WHEEL CHOCK WITH EYELET, model RWC-8, SEE PAGE A33



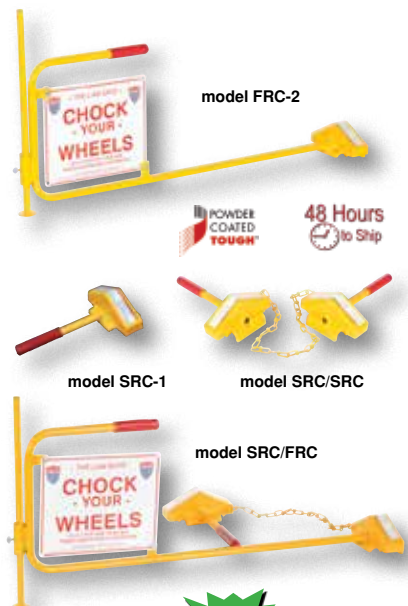

Universal Steel Rail Chocks

The Single Steel Rail Chock fits most standard size rails. The baked-in powder-coated toughness steel construction is designed to sustain longevity through use in a variety of harsh environments. The double sided flanges keep chocks on track and the hardened steel spurs that are located on the bottom side of the chock, are used to maximize a positive grip.

Model SRC/SRC features a 30" long chain which connects the combo sets together for added security. Handle length is 10".

Model FRC-2 & SRC/FRC has a handle projection of 36". Handle height is 14". The adjustable support legs are used to balance the Flag Rail Chocks. Chain length is 30" on combo units. The Aluminum "Chock Your Wheels" sign is visible from both sides. Steel construction.

MODEL NUMBER	DESCRIPTION	WEIGHT (POUND)
FRC-2 [Ⓢ]	FLAG RAIL CHOCK W/ADJUSTABLE HEIGHT LEG	15
SRC-1 [Ⓢ]	SINGLE RAIL CHOCK	8
SRC/FRC [Ⓢ]	SINGLE RAIL CHOCK / FLAG RAIL CHOCK COMBO	23
SRC/SRC [Ⓢ]	SINGLE RAIL CHOCK / SINGLE RAIL CHOCK COMBO	16



Magnetic Rail Car Wheel Chock

The Magnetic Rail Car Wheel Chock is designed to stabilize railcar wheels while loading and unloading. Standard features include; rail track attaching magnets for extra grip, pick up holes for easy transportation, a nylon material design for durability and longevity, and orange color for safety. Model RC-WC-HOOK allows you to pick up the Rail Chock without bending over.

MODEL NUMBER	WIDTH	LENGTH	HEIGHT	WEIGHT (POUND)
RC-WC [Ⓢ]	2¼"	11"	3 ⁵ / ₈ "	3
RC-WC-HOOK		4¾"	30"	2

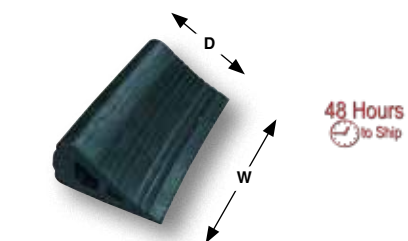

Industrial Rubber Wedges

Excellent for safety when stacking cylindrical objects. These extruded rubber wedges offer several advantages over wooden blocks or other forms of wedges: its resilience avoids creasing or wrinkling paper as well as scratching or marring surfaces; it increases its grip as weight is increased.

MODEL NUMBER	WIDTH	DEPTH	HEIGHT	WEIGHT (POUND)
RBW-2 [Ⓢ]	4"	6½"	3"	2
RBW-3 [Ⓢ]	6"	6½"	3"	5
RBW-5 [Ⓢ]	12"	6¾"	3"	7
RBW-10 [Ⓢ]	24"	6¾"	3"	12



Trailer Jacks

The Trailer Jack adjustable lift range provides easy hitching and unhitching of a loaded trailer. Use for a wide variety of lifting, leveling, and adjustment applications. Ideal for industrial, utility, construction, or agricultural equipment trailers. Heavy-duty construction. Available with a side or top crank position. Mounting bracket attaches in a variety of ways in order to meet your application needs. Scissor jacks provide stability and leveling to unattached trailers and equipment.

TYPE	MODEL NUMBER	MOUNT	CRANK POSITION	UNIFORM CAPACITY	LIFT RANGE	WEIGHT (POUND)
A	TJ-06 [Ⓢ]	SIDE SWIVEL/WHEEL	SIDE	800 lb.	10"	15
B	TJ-F3 [Ⓢ]	TUBE RING	TOP	2,000 lb.	15"	15
C	TJ-F1 [Ⓢ]	TUBE RING	TOP	1,000 lb.	10"	13
D	TJ-F2 [Ⓢ]	FLANGE	TOP	1,000 lb.	10"	17
E	TJ-F4 [Ⓢ]	FLANGE	TOP	2,000 lb.	15"	19
F	TJ-AF [Ⓢ]	A-FRAME	TOP	2,000 lb.	10"	14
G	FJ-K1 [Ⓢ]	A-FRAME	SIDE	1,000 lb.	15"	13
H	FJ-K2 [Ⓢ]	A-FRAME	SIDE	2,000 lb.	15"	14
--	CT-02	CRANK JACK	TOP	2,000 lb.	14"	11
I	NJ-BP [Ⓢ]	NOSE JACK BASE PAD		--	--	3
J	NJ-CR [Ⓢ]	NOSE JACK CASTER		--	--	2
K	SJ-7523	SCISSOR JACK		7,500 lb.	23"	17
K	SJ-7529	SCISSOR JACK		7,500 lb.	29"	19
-	SJ-HDL	OPTIONAL HANDLE FOR SJ-7523 & SJ-7529				1

Trailer Stabilizing Jacks

Jacks are used to prevent up-ending of semi-trailers when they are not connected to a tractor during loading and unloading operations. Also used to level trailers parked on sloped ground and to prevent landing gear from sinking into a soft surface. High strength steel construction. Flush-type zerk fitting for lubricating ACME screw. Meets OSHA regulations when used with wheel chocks. Baked-in powder-coated toughness. Includes reflective collar for visibility at night.



model SJS-1012

model SAJ-1012

TYPE	MODEL NUMBER	DESCRIPTION	UNIFORM STATIC CAPACITY	UNIFORM LIFTING CAPACITY	SERVICE RANGE	WHEEL SIZE & TYPE	WEIGHT (POUND)
A	BFSJ-2748	BIG FOOT JACK	100,000 lb.	40,000 lb.	39½" to 51"	10" hard rubber	162
B	LO-J-BEAM	RATCHET BEAM	100,000 lb.	40,000 lb.	40" to 51"	10" x 2" hard rubber	182
C	SP-TOP-BEAM	SPIN TOP BEAM	100,000 lb.	40,000 lb.	40" to 51"	10" x 2" hard rubber	200
D	H-LO-J-BEAM	HYDRAULIC BEAM	100,000 lb.	40,000 lb.	41" to 47"	10" x 2" hard rubber	175
E	CJ-BEAM-SN	HAND CRANK	100,000 lb.	50,000 lb.	41" to 55"	16" solid foam	238
E	CJ-BEAM-PN	HAND CRANK	100,000 lb.	50,000 lb.	41" to 55"	16" fully pneumatic	221
		CJ-BEAM-RHDL			OPTIONAL RATCHET HANDLE FOR BETTER ERGONOMICS FOR CJ-BEAM JACKS		8
F	SJ-40	ECONOMY (flat base)	50,000 lb.	5,000 lb.	44" to 51"	N/A	44/UPS
G	LO-J	RATCHET	100,000 lb.	40,000 lb.	39" to 51"	10" hard rubber	137
H	HI-J	RATCHET	100,000 lb.	40,000 lb.	45" to 57"	10" hard rubber	141
I	SP-TOP	SPIN TOP	100,000 lb.	40,000 lb.	39½" to 51"	10" hard rubber	129
J	SP-TOP-R	RATCHET	100,000 lb.	40,000 lb.	39½" to 51"	10" hard rubber	138
K	SJ-35	ECONOMY (rounded base)	50,000 lb.	5,000 lb.	44" to 51"	N/A	39/UPS
L	SJ-35-2H	ECONOMY	50,000 lb.	5,000 lb.	44" to 51"	N/A	39/UPS
M	SJ-35-EF	ECONOMY	50,000 lb.	5,000 lb.	41" to 57½"	8" hard rubber	102
TRAILER STABILIZING JACK OPTIONS							
	JACK-100	50,000 POUNDS LIFTING CAPACITY (NOT AVAILABLE ON SJ series)					18
	SJS-1012	ALUMINUM STABILIZING JACK TRAILER INSTRUCTION SIGN					1
	SAJ-1012	ALUMINUM DRIVERS BEWARE INSTRUCTION SIGN					1

Mechanical Screw Jacks

Acme thread post supports load. No seals to leak. Will not drift down even after an extended period of time.

MODEL NUMBER	UNIFORM CAPACITY (TONS)	LOWERED HEIGHT	RAISED HEIGHT	TRAVEL (INCHES)	WEIGHT (POUND)
MSJ-3	3	8¾"	13"	4¼"	12
MSJ-5	5	9¾"	15"	5¼"	18
MSJ-10	10	11"	17"	6"	20
MSJ-20	20	12¾"	20"	7¼"	29

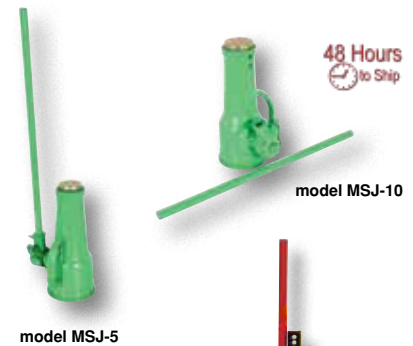

Heavy Duty Farm Jacks

Designed to lift, pull, push, and move heavy machinery and heavy objects. Ideal for lifting tractor and 4-wheel drive vehicles, tensioning wire fences, and pulling/pushing or removing posts, poles, tree stumps, etc. Hydraulic free, full lever mechanical operation. Solid cast iron construction. Heavy duty 33" ratchet operating lever provides maximum leverage.

MODEL NUMBER	UNIFORM CAPACITY (TONS)	LOWERED HEIGHT	RAISED HEIGHT	TRAVEL (INCHES)	WEIGHT (POUND)
HDFJ-48	3.5	6"	42"	36"	31
HDFJ-60	3.5	6"	53"	47"	36





HORIZONTAL BUMPER
TYPE A



VERTICAL BUMPER
TYPE B



ANGLE FLAT BUMPER
TYPE C

Laminated Dock Bumpers

Laminated style dock bumpers provide durable, economical protection for your loading dock and trailers. Units are constructed of fabric reinforced rubber from recycled truck tires. Pads are laminated between painted structural angles and held together with 3/4" steel tie rods. A metal plate is located on the back of the 96" wide bumpers for support. Installation is quick and easy by bolting or welding units to the dock. *Width is measured bolt hole center to bolt hole center* (with the exception of style C). Bolt holes are 13/16" diameter on type A & C bumpers and 7/8" diameter on type B bumpers. Contact factory for other sizes.

4.5" PROJECTION LAMINATED DOCK BUMPERS				
TYPE	MODEL NUMBER	DIMENSIONS (H x W x P)	NO. OF HOLES	WEIGHT (POUND)
A	1012-4.5	10" x 12" x 4 1/2"	4	22
A	1014-4.5	10" x 14" x 4 1/2"	4	25
A	1018-4.5	10" x 18" x 4 1/2"	4	36
A	1024-4.5	10" x 24" x 4 1/2"	4	45
A	1030-4.5	10" x 30" x 4 1/2"	4	60
A	1036-4.5	10" x 36" x 4 1/2"	4	68
A	1096-4.5	10" x 96" x 4 1/2"	4	191
A	1212-4.5	12" x 12" x 4 1/2"	4	24
A	1214-4.5	12" x 14" x 4 1/2"	4	31
A	1218-4.5	12" x 18" x 4 1/2"	4	41
A	1224-4.5	12" x 24" x 4 1/2"	4	56
A	1230-4.5	12" x 30" x 4 1/2"	4	69
A	1236-4.5	12" x 36" x 4 1/2"	4	88
A	1296-4.5	12" x 96" x 4 1/2"	4	215
A	624-4.5	6" x 24" x 4 1/2"	4	26
A	636-4.5	6" x 36" x 4 1/2"	4	45
C	1014-4.5F	10" x 12 3/16" x 4 1/2"	2	32
C	1214-4.5F	12" x 12 3/16" x 4 1/2"	2	32
B	V-1120-4.5	20" x 11" x 4 1/2"	6	39
B	V-1124-4.5	24" x 11" x 4 1/2"	6	40
B	V-1130-4.5	30" x 11" x 4 1/2"	8	92
B	V-1136-4.5	36" x 11" x 4 1/2"	8	123

6" PROJECTION LAMINATED DOCK BUMPERS				
TYPE	MODEL NUMBER	DIMENSIONS (H x W x P)	NO. OF HOLES	WEIGHT (POUND)
A	1012-6	10" x 12" x 6"	4	24
A	1014-6	10" x 14" x 6"	4	34
A	1018-6	10" x 18" x 6"	4	43
A	1024-6	10" x 24" x 6"	4	58
A	1030-6	10" x 30" x 6"	4	64
A	1036-6	10" x 36" x 6"	4	89
A	1212-6	12" x 12" x 6"	4	31
A	1214-6	12" x 14" x 6"	4	39
A	1218-6	12" x 18" x 6"	4	51
A	1224-6	12" x 24" x 6"	4	67
A	1230-6	12" x 30" x 6"	4	73
A	1236-6	12" x 36" x 6"	4	94
A	1296-6	12" x 96" x 6"	4	316
B	V-1120-6	20" x 11" x 6"	6	50
B	V-1124-6	24" x 11" x 6"	6	61
B	V-1130-6	30" x 11" x 6"	8	76
B	V-1136-6	36" x 11" x 6"	8	134

ANCHOR BOLTS HARDWARE FOR CONCRETE INSTALLATION		
MODEL NUMBER	QUANTITY AND SIZE	WEIGHT (POUND)
AS-344	(1) 3/4" x 4 1/4"	1
AS-344-4PK	(4) 3/4" x 4 1/4"	4

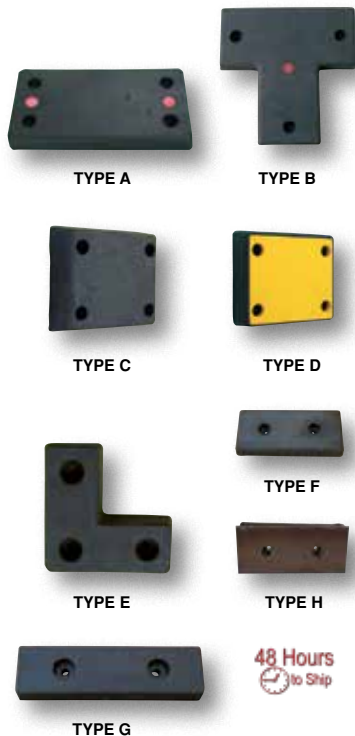

Specialty Molded Dock Bumpers

Manufactured from fiber reinforced prime rubber containing nylon and polyester. These molded bumpers are built to endure years of abusive pounding. All units have pre-drilled countersunk mounting holes for easy installation. Plastic face bumper, model B-1213-4PF, features two (2) piece construction fully assembled and ready for installation.

TYPE	MODEL NUMBER	OVERALL SIZE (WIDTH x HEIGHT x PROJECTION)	# OF HOLES & SIZE	WEIGHT (POUND)
A	B-1224-3	24" x 12" x 3"	4, 3/4"	34
A	B-1224-6	24" x 12" x 6"	4, 3/4"	57
B	T-22	22" x 22" x 3"	3, 3/4"	44
C	B-1213-4	12" x 13" x 4"	4, 3/4"	24
D	B-1213-4PF	12" x 13" x 4"	4, 3/4"	24
E	L-1818-4	18" x 18" x 4"	3, 1"	36
F	B-516	16" x 5" x 2"	2, 5/8"	8
G	B-818	18" x 8" x 2"	2, 5/8"	16
H	B-516-SF	16"W x 5"H x 2 1/2"P STEEL FACED MOLDED BUMPER	2, 3/4"	21
--	B-818-SF	18"W x 8"H x 2 1/2"P STEEL FACED MOLDED BUMPER	2, 3/4"	35

ANCHOR BOLTS HARDWARE FOR CONCRETE INSTALLATION		
MODEL NUMBER	QUANTITY AND SIZE	WEIGHT (POUND)
AS-346	(1) 3/4" x 6 1/4"	1
AS-346-4PK	(4) 3/4" x 6 1/4"	4
AS-584	(1) 5/8" x 4"	1
AS-584-4PK	(4) 5/8" x 4"	4



Extruded Bumpers

Made of all weather and abrasion resistant rubber. The half-oval shape allows for effective fendering action over a wide radius. A metal plate is located inside 4" and 6" projection bumpers for support while the 2" unit comes with one washer per hole (this does not include the 120" long models). Custom lengths available up to 10 feet. Installation hardware sold separately, see below.



TYPE A • M-2-SERIES



TYPE B • M-4-SERIES

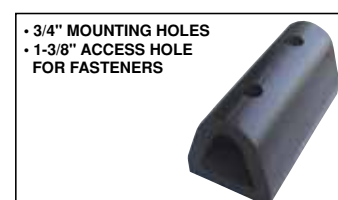

TYPE C • M-6-SERIES

TYPE	MODEL NUMBER	OVERALL SIZE (L x W x H)	# OF HOLES & SIZE	WEIGHT (POUND)
A	M-2-12 [Ⓢ]	12"L x 2"W x 1¾"H	2, 3/8"	2
A	M-2-18 [Ⓢ]	18"L x 2"W x 1¾"H	2, 3/8"	2
A	M-2-24 [Ⓢ]	24"L x 2"W x 1¾"H	2, 3/8"	3
A	M-2-36 [Ⓢ]	36"L x 2"W x 1¾"H	3, 3/8"	3
A	M-2-120 [Ⓢ]	120"L x 2"W x 1¾"H	0	13
B	M-4-12 [Ⓢ]	12"L x 4¼"W x 4"H	2, 3/4"	8
B	M-4-18 [Ⓢ]	18"L x 4¼"W x 4"H	2, 3/4"	10
B	M-4-24 [Ⓢ]	24"L x 4¼"W x 4"H	2, 3/4"	14
B	M-4-36 [Ⓢ]	36"L x 4¼"W x 4"H	3, 3/4"	18
B	M-4-120 [Ⓢ]	120"L x 4¼"W x 4"H	0	56
C	M-6-12 [Ⓢ]	12"L x 6"W x 6"H	2, 3/4"	14
C	M-6-18 [Ⓢ]	18"L x 6"W x 6"H	2, 3/4"	18
C	M-6-24 [Ⓢ]	24"L x 6"W x 6"H	2, 3/4"	24
C	M-6-36 [Ⓢ]	36"L x 6"W x 6"H	3, 3/4"	34
C	M-6-120 [Ⓢ]	120"L x 6"W x 6"H	0	137
ANCHOR BOLTS HARDWARE FOR CONCRETE INSTALLATION				
---	AS-383 [Ⓢ]	(1) 3/8" x 3", USE WITH M-2 SERIES		1
---	AS-383-4PK [Ⓢ]	(4) 3/8" x 3", USE WITH M-2 SERIES		4
---	AS-344 [Ⓢ]	(1) 3/4" x 4¼", USE WITH M-4 & M-6 SERIES		1
---	AS-344-4PK [Ⓢ]	(4) 3/4" x 4¼", USE WITH M-4 & M-6 SERIES		4

Trailer Crane Bumpers

Manufactured from fiber reinforced prime rubber containing nylon to resist abrasion, impact, wear, and corrosion. Impervious to weather damage. All models have pre-drilled, countersunk mounting holes for easy installation. Installation hardware available separately, see below.

MODEL NUMBER	WIDTH	LENGTH	PROJECTION	COLOR	# OF HOLES & SIZE	WEIGHT (POUND)
TB-10 [Ⓢ]	3"	6"	2 ^{15/16} "	BLACK	2, 5/8"	3
TB-20 [Ⓢ]	3½"	6"	3½"	BLACK	2, 5/8"	5
TB-70 [Ⓢ]	2"	16"	2"	BLACK	3, 1/2"	3
TB-70-Y [Ⓢ]	2"	16"	2"	YELLOW	3, 1/2"	3
TB-90 [Ⓢ]	5 ^{5/8} "	7 ^{5/8} "	3¾"	BLACK	4, 5/8"	6
ANCHOR BOLTS HARDWARE FOR CONCRETE INSTALLATION						
AS-125 [Ⓢ]	(1) 1/2" x 5", USE WITH TB-10, TB-20, TB-70, TB-70-Y					1
AS-125-4PK [Ⓢ]	(4) 1/2" x 5", USE WITH TB-10, TB-20, TB-70, TB-70-Y					4
AS-584 [Ⓢ]	(1) 5/8" x 4", USE WITH MODEL TB-90					1
AS-584-4PK [Ⓢ]	(4) 5/8" x 4", USE WITH MODEL TB-90					4



model TB-10

model TB-20

model TB-90



model TB-70



model TB-70-Y

Hardened Molded Bumpers

These pre-drilled bumpers are constructed of fiber reinforced rubber containing nylon and polyester for all weather conditions. Provides high impact resistance. Steel reinforcement rings are molded into each bumper for installation. Uses ¾" anchor bolts. Sold individually. Order installation hardware separately, see below.

MODEL NUMBER	WIDTH	LENGTH	PROJECTION	# OF HOLES & SIZE	WEIGHT (POUND)
DBE-10-1 [Ⓢ]	4½"	10"	3"	2, 5/8"	6
DBE-20-1 [Ⓢ]	4½"	20"	3"	4, 5/8"	13
DBE-30-1 [Ⓢ]	4½"	30"	3"	5, 1/2"	16
ANCHOR BOLTS HARDWARE FOR CONCRETE INSTALLATION					
AS-584 [Ⓢ]	(1) 5/8" x 4"				1
AS-584-4PK [Ⓢ]	(4) 5/8" x 4"				4



model DBE-10-1



model DBE-30-1



model BS-18

48 Hours
to Ship

Extruded Bumper Stops

Ideal for building and machinery protection. Bumper Stops are excellent for protecting vehicles when parking places are located next to building walls and trucks at docks. Made of strong, durable, high impact resistant solid rubber. Easy installation either horizontally or vertically. Accepts a 3/8" flat head anchor bolt. Installation hardware available separately, see below.

MODEL NUMBER	WIDTH	LENGTH	PROJECTION	# OF HOLES & SIZE	WEIGHT (POUND)
BS-12	5 1/2"	12"	1 1/4"	2, 3/8"	4
BS-18	5 1/2"	18"	1 1/4"	2, 3/8"	5
BS-24	5 1/2"	24"	1 1/4"	3, 3/8"	7
BS-36	5 1/2"	36"	1 1/4"	4, 3/8"	10
ANCHOR BOLTS HARDWARE FOR CONCRETE INSTALLATION					
AS-383	(1) 3/8" x 3"				1
AS-383-4PK	(4) 3/8" x 3"				4



48 Hours
to Ship

New

Rounded Dome Bumpers

Great for use under equipment for protecting surfaces. Isolate equipment from impact and vibration. Non-marking polyurethane rubber material. Pressure sensitive adhesive backing to peel and stick.

MODEL NUMBER	DIAMETER	HEIGHT	PACKAGE QUANTITY	NET WEIGHT (PER PKG. POUND)
RDB-075	3/4"	0.375"	50	1
RDB-125	1 1/4"	0.625"	25	1
RDB-200	2"	1.000"	15	1
RDB-250	2 1/2"	1.250"	10	2



Dock Safety Guides

Highly visible reflective caution signs are constructed from aluminum. Bolt directly to your loading dock to help guide drives as they back into the loading dock. Variety of OSAH signage available in Facility Maintenance section.

MODEL NUMBER	OVERALL SIZE (W x H)	WEIGHT (POUND)
DSR-28	6" x 28"	2



model AS-344-4PK

48 Hours
to Ship



model BIT-1/2

Installation Hardware

Secure your product to a concrete surface. Works with a wide variety of equipment which is featured throughout this catalog.

MODEL NUMBER	DIAMETER	OVERALL LENGTH	SLEEVE LENGTH	QUANTITY	WEIGHT (POUND)
AS-124	1/2"	4"	7/8"	1	1
AS-124-4PK	1/2"	4"	7/8"	4	4
AS-125	1/2"	5 1/2"	3"	1	1
AS-125-4PK	1/2"	5 1/2"	3"	4	4
AS-383	3/8"	3"	1"	1	1
AS-383-4PK	3/8"	3"	1"	4	4
AS-344	3/4"	4 1/4"	2"	1	1
AS-344-4PK	3/4"	4 1/4"	2"	4	4
AS-346	3/4"	6 1/4"	3"	1	1
AS-346-4PK	3/4"	6 1/4"	3"	4	4
AS-584	5/8"	4"	3"	1	1
AS-584-4PK	5/8"	4"	3"	4	4
CONCRETE DRILL BIT					
BIT-3/8	3/8"	6"	---	1	1
BIT-1/2	1/2"	6"	---	1	1
BIT-3/4	3/4"	6"	---	1	1



Economy Trailer King Pin Lock

Trailer King Pin Lock provides security for trailers and RV's. Lock slides onto a trailer's king pin to prevent a thief from pulling up, hitching, and driving off with your trailer. No tools are required, just slide the king pin lock into place and turn the key. Units are baked-in powder-coated toughness and come with two (2) keys, keyed alike.



48 Hours
to Ship

POWDER COATED TOUGH

MODEL NUMBER	DESCRIPTION	HEIGHT	INSIDE DIAMETER	WEIGHT (POUND)
E-TKPL	KING PIN LOCK	3 1/4"	3"	3

Pallet Buster

Refurbish or remove broken and unsightly pallets quickly and safely. Lightweight and easy to use. Can be utilized to raise a dockboard for fork truck removal. Model SKB-7 features a unique dual prying action with nail puller. Deluxe unit features baked-in powder-coated toughness.

MODEL NUMBER	DESCRIPTION	BAR LENGTH	HANDLE DIAMETER	WEIGHT (POUND)
SKB-7 [®]	PALLET BUSTER	41½"	1¼"	9
SKB-DLX [®]	DELUXE PALLET BUSTER	41"	1¼"	16



Prylever Bars

Provide dock workers, riggers, and freight handlers with the leverage needed to get underneath heavy objects for transporting with fork truck, hand truck, pallet truck, or machinery movers. Two (2) 5" x 2" poly-on-steel wheels. ⅝" thick steel nose plate with beveled edge is bolted on the wood handle units and welded on the steel units. Steel units feature baked-in powder-coated toughness.

MODEL NUMBER	HANDLE TYPE	BAR LENGTH	USABLE NOSE PLATE (W x D)	UNIFORM CAPACITY	WEIGHT (POUND)
PLB-5 [®]	WOOD	5'	7⅛" x 3⅛"	4,250 lb.	31
PLB-6 [®]	WOOD	6'	7⅛" x 3⅛"	4,250 lb.	32
PLB-7 [®]	WOOD	7'	7⅛" x 3⅛"	4,250 lb.	35
PLB/S-5 [®]	STEEL	5'	6"W x 3½"	5,000 lb.	37
PLB/S-6 [®]	STEEL	6'	6"W x 3½"	5,000 lb.	42
PLB/S-7 [®]	STEEL	7'	6"W x 3½"	5,000 lb.	47
HIGH CAPACITY STEEL PRYLEVER BARS					
PLB/S-55-6-SBW	STEEL	55"	2½" x 2"	6,000 lb.	18
PLB/S-59-11-SBW	STEEL	59"	3" x 2⅝"	11,000 lb.	26



Pallet Pullers

Pallet Pullers are used to pull pallets to rear of trailers for easy fork truck access. Rugged steel construction. Heads are self-cleaning and unaffected by wood particles, paint, or grease. Pallet pullers are NOT designed for lifting.

PAL-12 and PAL-16 - Single scissor action allows for wider jaw opening.

PAL-14 - Cam closing action provides maximum gripping strength and reduces pinch points. Safety handle enables easier positioning and removal. Grips both metal and wood pallets with biting action.

PAL-21 and PAL-LP - One piece curved heads have integral spurs for gripping pallet stringers.

MODEL NUMBER	DESCRIPTION	UNIFORM PULLING CAPACITY	JAW HEIGHT	JAW OPENING	WEIGHT (POUND)
PAL-12 [®]	SINGLE SCISSOR	5,000 lb.	2¾"	7"	14
PAL-16 [®]	HEAVY-DUTY SINGLE SCISSOR	6,000 lb.	2"	5"	21
PAL-14 [®]	CAM ACTION	5,000 lb.	1½"	3"	17
PAL-21 [®]	DOUBLE SCISSOR	5,000 lb.	2¾"	3"	25
PAL-LP [®]	LOW PROFILE DOUBLE SCISSOR	5,000 lb.	2"	3¼"	24
PPC-20 [®]	20' OF ¼" CHAIN W/GRAB HOOKS	6,000 lb.	---	---	14
PPC-40 [®]	40' OF ¼" CHAIN W/GRAB HOOKS	6,000 lb.	---	---	28

NOT FOR LIFTING



Security Seals

Seal trailers, gates, hatches, and doors with these general purpose security seals. Reveals the slightest tampering attempts. Two (2) colors and four (4) styles to choose from. Polypropylene construction. Sold only in packages of 100.

MODEL NUMBER	STAMPED MARKINGS	LENGTH	SEQUENTIALLY NUMBERED	WEIGHT (POUND)
SECS-B9-BL [®]	SEALED - DO NOT REMOVE	14⅛"	NO	2
SECS-B9-RD [®]	SEALED - DO NOT REMOVE	14⅛"	NO	2
SECS-F7-BL [®]	SEALED	8⅛"	YES	1
SECS-F7-RD [®]	SEALED	8⅛"	YES	1
SECS-L11-BL [®]	SEALED	15"	YES	2
SECS-L11-RD [®]	SEALED	15"	YES	2
SECS-P-BL [®]	SEALED	3"	YES	1
SECS-P-RD [®]	SEALED	3"	YES	1



D-150, D-350, D-150/650 & D-750 DOCK SEAL & SHELTER

SURVEY SHEET

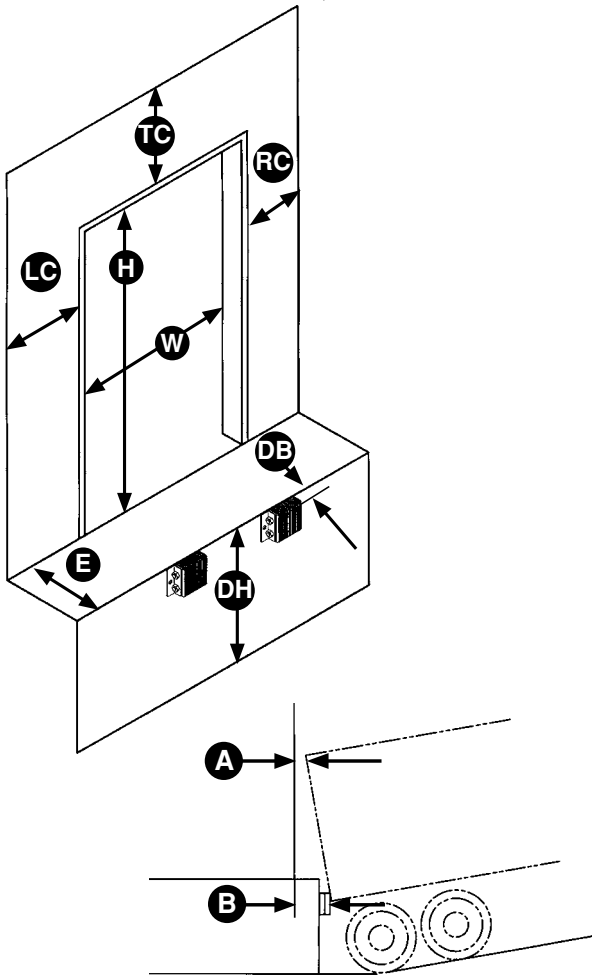

CUSTOMER INFORMATION

CONTACT: _____
 COMPANY: _____
 PHONE: _____
 EMAIL: _____

DOOR SIZE

(W) WIDTH OF OPENING: _____ (inches)
 (H) HEIGHT OF OPENING: _____ (inches)
 (LC) LEFT CLEARANCE: _____ (inches)
 (RC) RIGHT CLEARANCE: _____ (inches)
 (TC) TOP CLEARANCE: _____ (inches)
 (E) EXTENSION FROM BUILDING: _____ (inches)
 (DB) DOCK BUMPER PROJECTION: _____ (inches)
 (DH) DOCK HEIGHT: _____ (inches)
 IS THIS DOOR NEXT TO ANOTHER DOOR THAT REQUIRES A SEAL/SHELTER? _____
 WILL/DOES THIS DOOR HAVE A FACE MOUNTED EDGE-O-DOCKLEVELER? _____

SPECIAL SIZE TRAILERS

HIGHEST TRAILER: _____ (inches)
 LOWEST TRAILER: _____ (inches)
 WIDEST TRAILER: _____ (inches)
 NARROWEST TRAILER: _____ (inches)

BUILDINGS WITH SLOPED DOCK APPROACH

(A) DISTANCE BETWEEN TRAILER AND BUILDING AT POINT A: _____ (inches)
 (B) DISTANCE BETWEEN TRAILER AND BUILDING AT POINT B: _____ (inches)

RR, EH or RU DOCK LEVELER

EXISTING PIT SURVEY SHEET

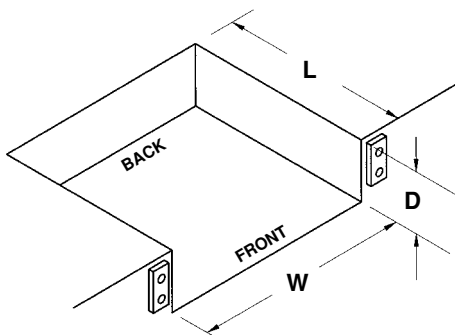

SPECIFICATIONS

	MECHANICAL	ELECTRIC HYDRAULIC	TRUCK ACTUATED	
CAPACITY:	20,000	25,000	30,000	35,000
	40,000	45,000	50,000	60,000
	70,000	80,000	90,000	100,000

EXISTING PIT SPECIFICATIONS

WIDTH (W): _____
 LENGTH (L): _____
 FRONT DEPTH (D): _____
 BACK DEPTH (D): _____

**** MEASURE PIT NOT EXISTING DOCK LEVELER ****



CATALOG REQUEST FORM

PLEASE SPECIFY QUANTITY

- _____ Loading Dock Equipment (40 pgs.)
- _____ Facility Maintenance (20 pgs.)
- _____ Ergonomic Solutions (56 pgs.)
- _____ Packaging Equipment (20 pgs.)
- _____ Protective Barriers (32 pgs.)
- _____ Fork Truck Attachments (20 pgs.)
- _____ Gantry & Jib Cranes (24 pgs.)
- _____ Ladders (20 pgs.)
- _____ Storage Solutions (24 pgs.)
- _____ Industrial Carts & Dollies (40 pgs.)
- _____ Drum Handling Equipment (48 pgs.)

VISIT: www.vestil.com/literature
EMAIL: literature@vestil.com
FAX: (800) 526-3133 or (260) 665-1339

Company _____

Attention _____

Address _____

City _____

State _____

Zip Code _____

Email _____



LOADING DOCK EQUIPMENT



VESTIL MANUFACTURING

2999 North Wayne Street, Post Office Box 507

Angola, Indiana 46703 USA

Phone (260) 665-7586 • (800) 348-0868

Fax (260) 665-1339 • (800) 526-3133

www.vestil.com

info@vestil.com - general company inquiries and price quotes

status@vestil.com - check order status

freight@vestil.com - freight quotes

orders@vestil.com - remit purchase orders

parts@vestil.com - replacement parts

tech@vestil.com - technical product support & troubleshooting